



## 2N7002BE

---

### N-Channel Enhancement Mode Field Effect Transistor

#### Product Summary

$V_{DS}$	60V
$I_D$	350mA
$R_{DS(ON)}$ ( at $V_{GS}=10V$ )	1000m
$R_{DS(ON)}$ ( at $V_{GS}=4.5V$ )	14



## 2N7002BE

### Electrical Characteristics ( $T_J=25$ unless otherwise noted)

Parameter	Symbol	Conditions	Min	Typ	Max	Units
<b>Static Parameter</b>						
Drain-Source Breakdown Voltage	$BV_{DSS}$	$V_{GS}=0V, I_D=250\mu A$	60	-	-	V
Zero Gate Voltage Drain Current	$I_{DSS}$	$V_{DS}=60V, V_{GS}=0V$	-	-	1	$\mu A$
		$V_{DS}=60V, V_{GS}=0V, T_J=150^\circ C$	-	-	100	
Gate-Body Leakage Current	$I_{GSS}$	$V_{GS}=\pm 30V, V_{DS}=0V$	-	-	$\pm 100$	nA
Gate Threshold Voltage	$V_{GS(th)}$	$V_{DS}=V_{GS}, I_D=250\mu A$	1.0	1.6	2.5	V
Static Drain-Source On-Resistance	$R_{DS(ON)}$	$V_{GS}=10V, I_D=350mA$	-	730	1000	m
		$V_{GS}=4.5V, I_D=200mA$	-	835	1400	
Diode Forward Voltage	$V_{SD}$	$I_S=350mA, V_{GS}=0V$	-	-	1.2	V



## Typical Electrical and Thermal Characteristics Diagrams

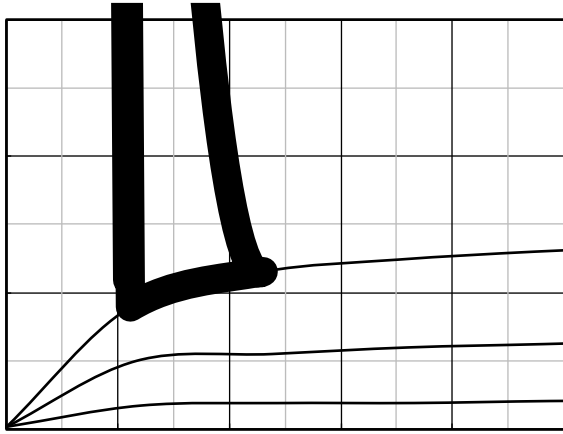

Figure 1. Output Characteristics

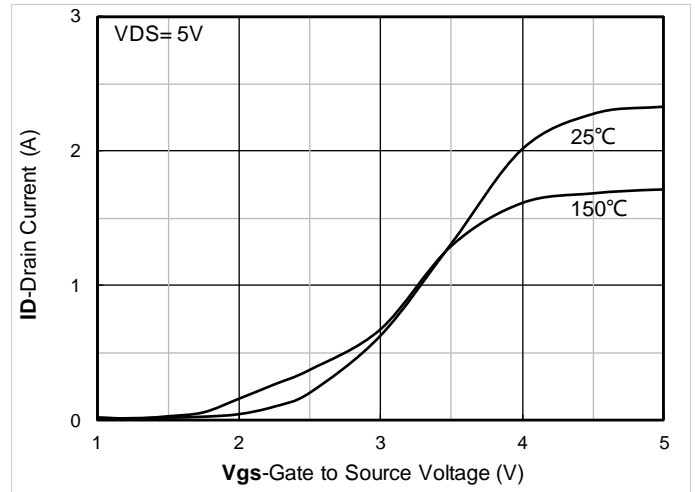

Figure 2. Transfer Characteristics

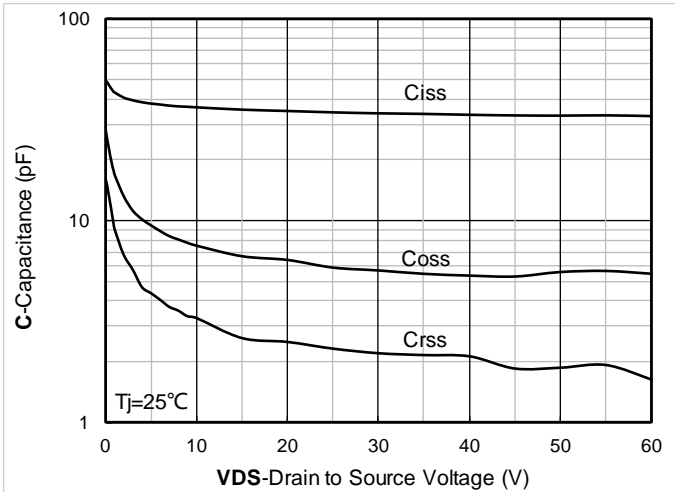

Figure 3. Capacitance Characteristics

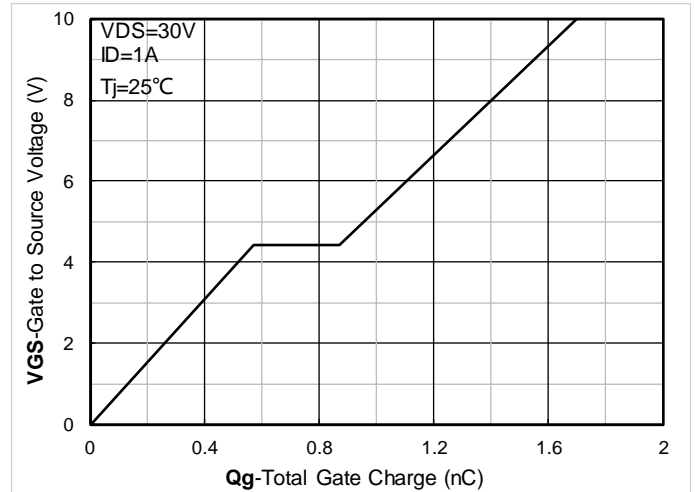

Figure 4. Gate Charge

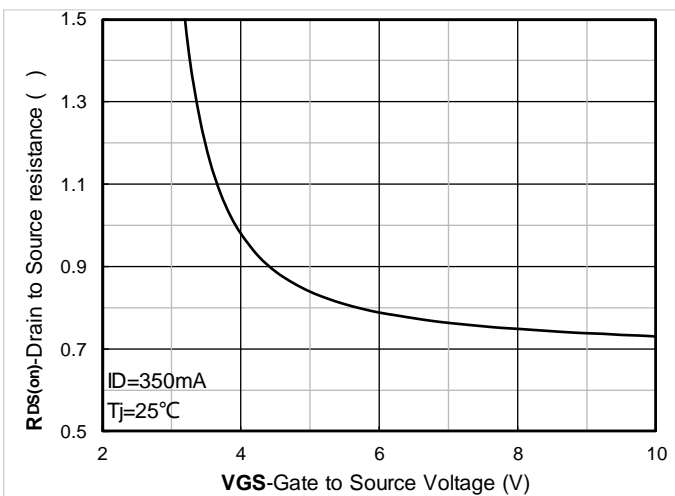

Figure 5. On-Resistance vs Gate to Source Voltage

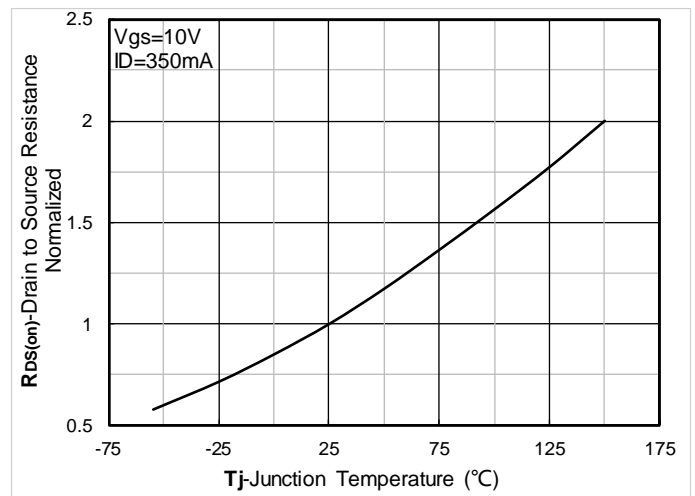

Figure 6. Normalized On-Resistance



# 2N7002BE

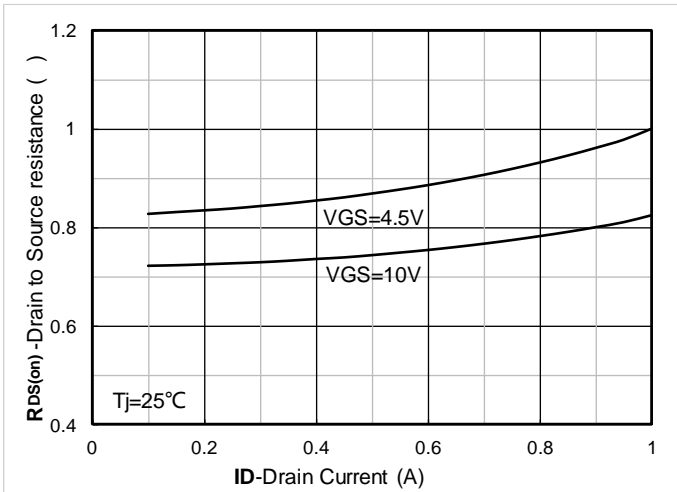

Figure 7. RDS(on) VS Drain Current

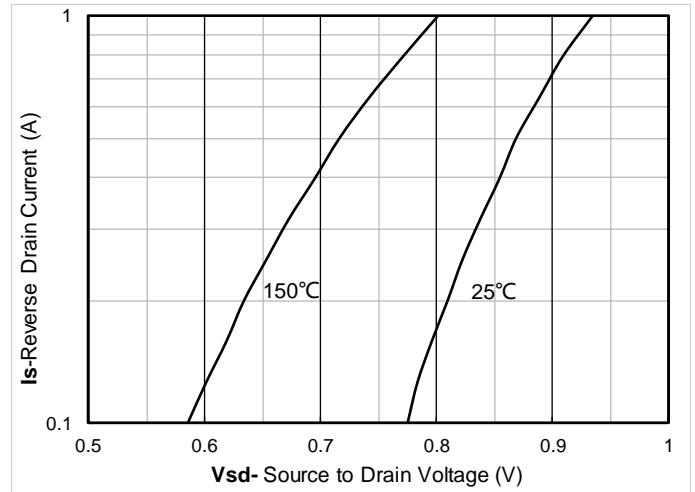

Figure 8. Forward characteristics of reverse diode

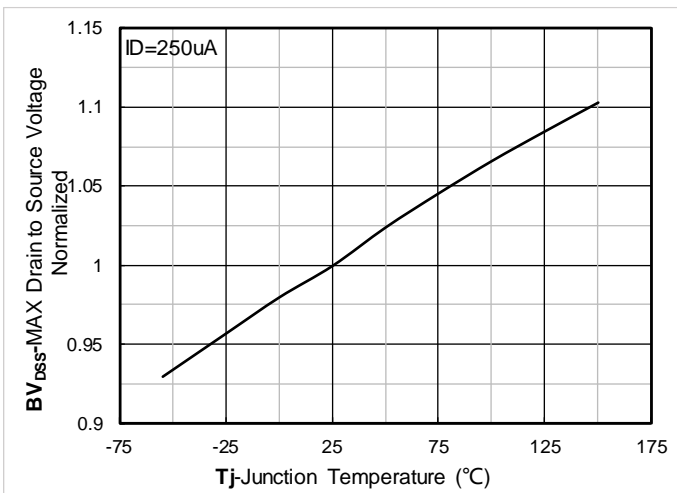

Figure 9. Normalized breakdown voltage

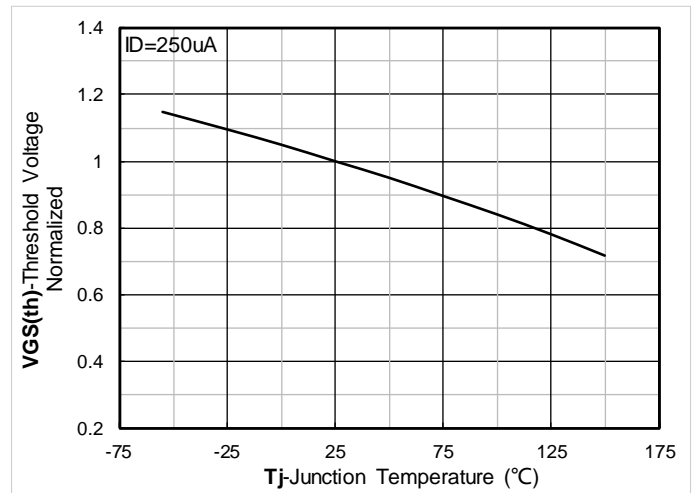

Figure 10. Normalized Threshold voltage

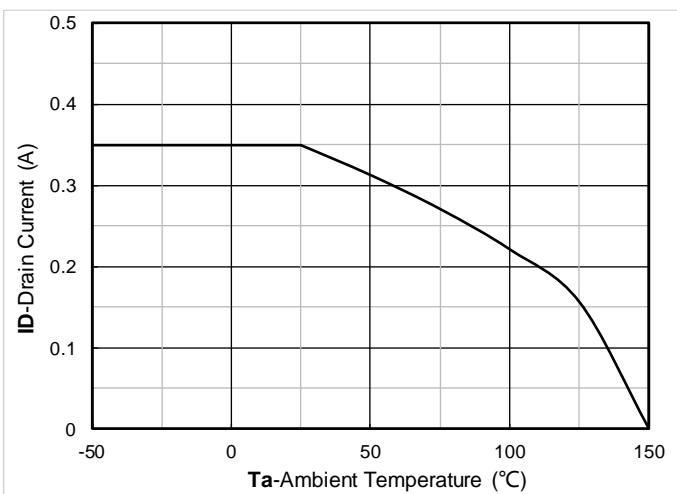

Figure 11. Current dissipation

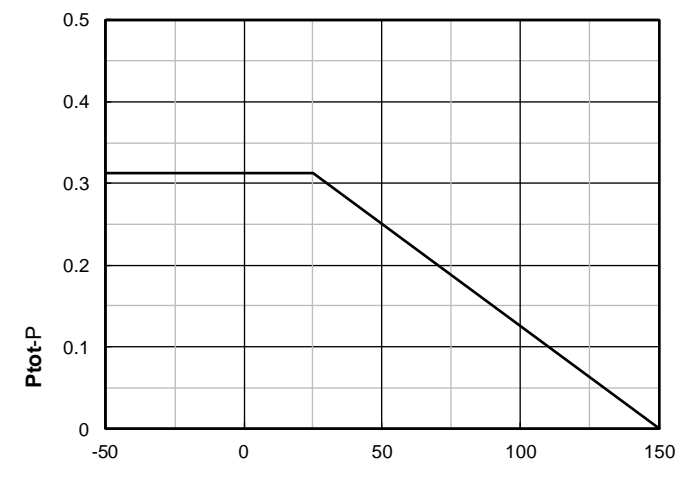

Figure 12. Power dissipation

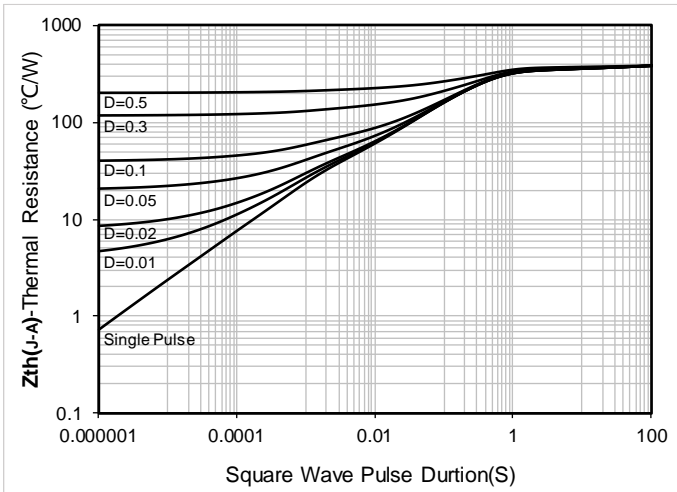

Figure 13. Maximum Transient Thermal Impedance

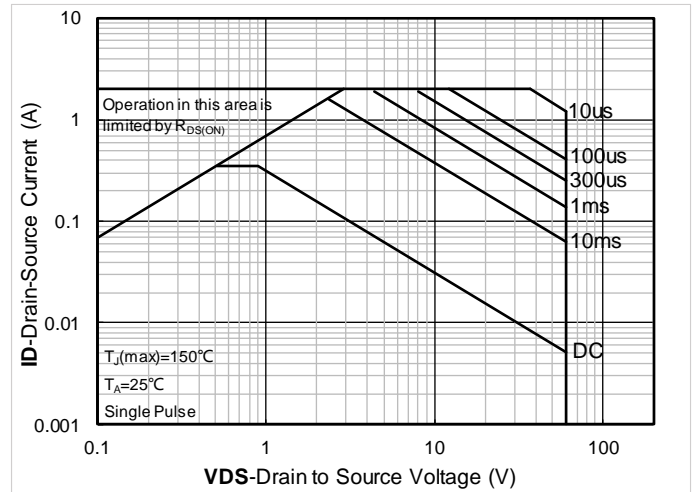

Figure 14. Safe Operation Area

## Test Circuits & Waveforms

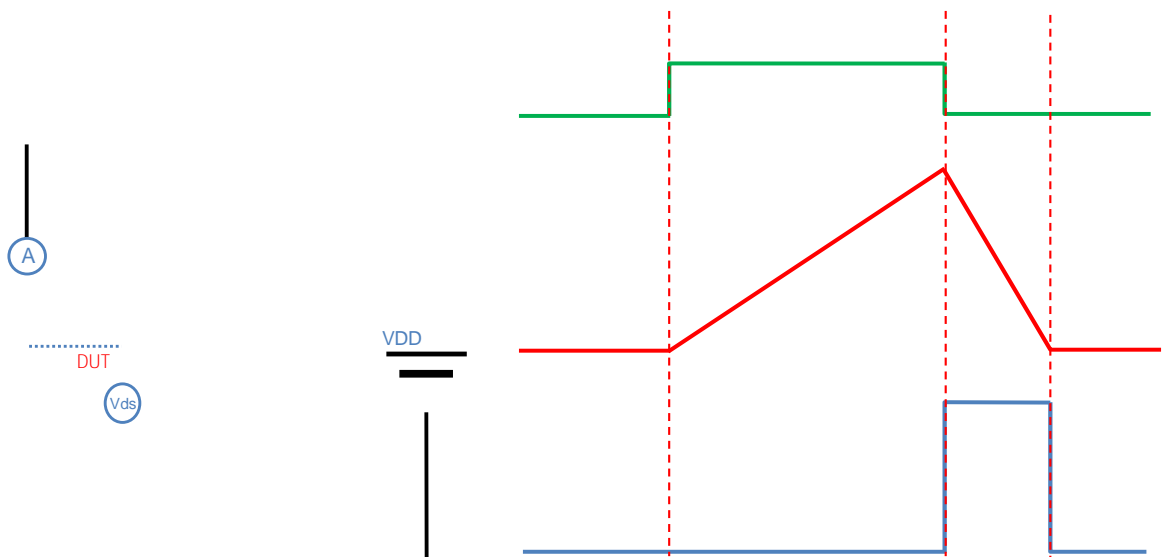

Figure A. Unclamped Inductive Switching (UIS) Test Circuit & Waveform

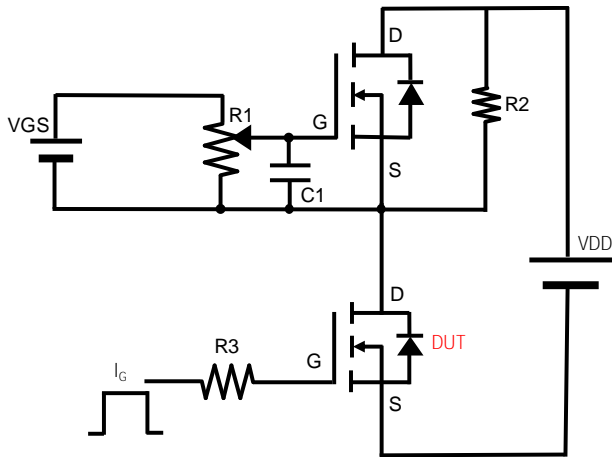

Figure B. Gate Charge Test Circuit & Waveform

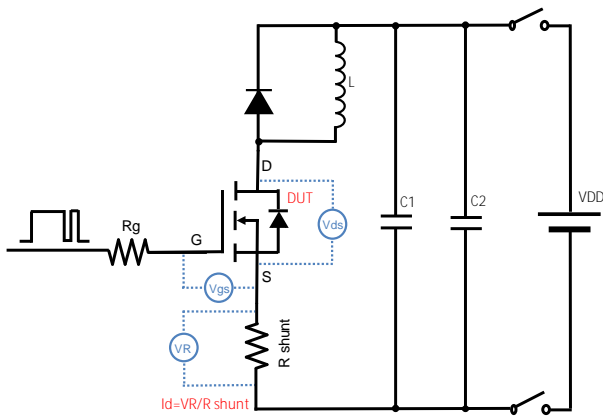

Figure C. Resistive Switching Test Circuit & Waveform

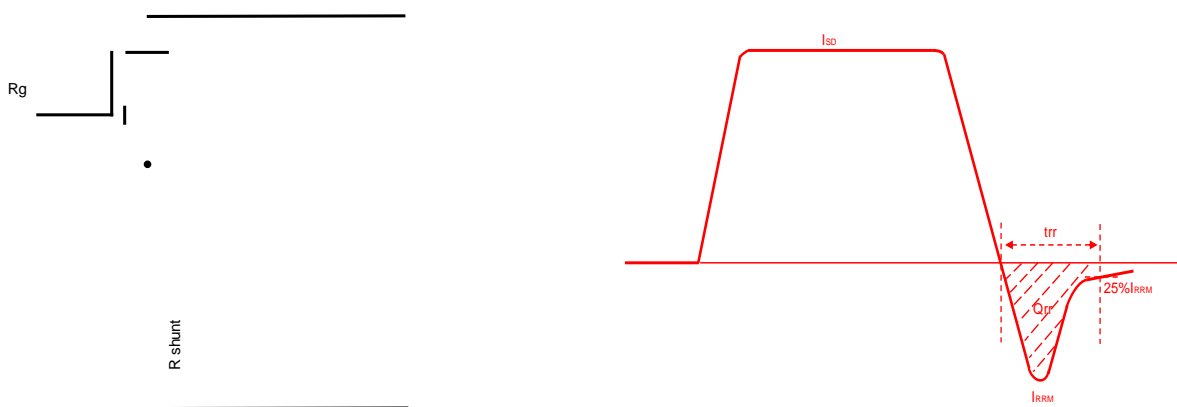
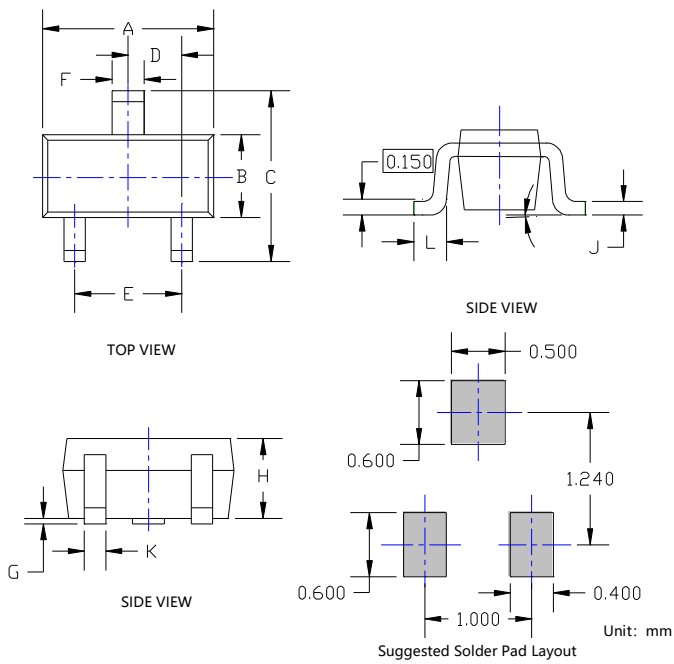

Figure D. Diode Recovery Test Circuit & Waveform



# 2N7002BE

## SOT-523 Package information



SYMBOL	DIMENSIONS			
	INCHES		Millimeter	
	MIN.	MAX.	MIN.	MAX.
A	0.059	0.067	1.500	1.700
B	0.030	0.033	0.750	0.850
C	0.057	0.069	1.450	1.750
D	0.020TYP		0.500TYP	
E	0.035	0.043	0.900	1.100
F	0.010	0.018	0.250	0.450
G	0.000	0.004	0.000	0.100
H	0.024	0.031	0.600	0.800
J	0.004	0.008	0.100	0.200
K	0.006	0.014	0.150	0.350
L	0.010	0.018	0.260	0.460
	0°	8°	0°	8°

NOTE:  
 1. PACKAGE BODY SIZES EXCLUDE MOLD FLASH AND GATE BURRS.  
 2. TOLERANCE 0.1mm UNLESS OTHERWISE SPECIFIED.  
 3. THE PAD LAYOUT IS FOR REFERENCE PURPOSES ONLY.



## 2N7002BE

---

### Disclaimer

The information presented in this document is for reference only. Yangzhou Yangjie Electronic Technology Co., Ltd. reserves the right to make changes without notice for the specification of the products displayed herein to improve reliability, function or design or otherwise.

The product listed herein is designed to be used with ordinary electronic equipment or devices, and not designed to be used with equipment or devices which require high level of reliability and the malfunction of which would directly endanger human life (such as medical instruments, transportation equipment, aerospace machinery, nuclear-reactor controllers, fuel controllers and other safety devices), Yangjie or anyone on its behalf, assumes no responsibility or liability for any damages resulting from such improper use of sale.

This publication supersedes & replaces all information previously supplied. For additional information, please visit our website <http://www.21yangjie.com> , or consult your nearest Yangjie's sales office for further assistance.