



2N7002C

N-Channel Enhancement Mode Field Effect Transistor

Product Summary

V_{DS}	60V
I_D	350mA
$R_{DS(ON)}$ (at $V_{GS}=10V$)	1.0
$R_{DS(ON)}$ (at $V_{GS}=4.5V$)	1.4

General Description

Trench Power MV MOSFET technology
Voltage controlled small signal switch
Low input Capacitance
Fast Switching Speed
Low Input / Output Leakage
Moisture Sensitivity Level 1
Epoxy Meets UL 94 V-0 Flammability Rating
Halogen Free

Applications

Battery operated systems
Solid-state relays
Direct logic-level interface TTL/CMOS

Absolute Maximum Ratings ($T_A=25$ unless otherwise noted)

Parameter	Symbol	Limit	Unit
-----------	--------	-------	------

Drain-source Voltage V_{DS} 24.12 ref* EMC q286.51 455.59 103.08 24.12 i



2N7002C

Electrical Characteristics ($T_J=25$ unless otherwise noted)

Parameter	Symbol	Conditions	Min	Typ	Max	Units
Static Parameter						
Drain-Source Breakdown Voltage	BV_{DSS}	$V_{GS}=0V, I_D=250\mu A$	60	-	-	V
Zero Gate Voltage Drain Current	I_{DSS}	$V_{DS}=60V, V_{GS}=0V$	-	-	1	μA
		$V_{DS}=60V, V_{GS}=0V, T_J=150$	-	-	100	
Gate-Body Leakage Current	I_{GSS}	$V_{GS}=\pm 30V, V_{DS}=0V$	-	-	± 100	nA
Gate Threshold Voltage	$V_{GS(th)}$	$V_{DS}=V_{GS}, I_D=250\mu A$	1.0	1.6	2.5	V
Static Drain-Source On-Resistance	$R_{DS(on)}$	$V_{GS}=10V, I_D=350mA$	-	0.7	1.0	
		$V_{GS}=4.5V, I_D=200mA$	-	0.85	1.4	
Diode Forward Voltage	V_{SD}	$I_S=350mA, V_{GS}=0V$	-	-	1.2	V
Gate resistance	R_G	$f=1MHz$	-	20	-	
Maximum Body-Diode Continuous Current	I_S		-	-	350	mA
Dynamic Parameters						
Input Capacitance	C_{iss}	$V_{DS}=30V, V_{GS}=0V, f=1MHz$	-	34	-	pF
Output Capacitance	C_{oss}		-	6	-	
Reverse Transfer Capacitance	C_{rss}		-	2	-	
Switching Parameters						
Total Gate Charge	Q_g	$V_{GS}=10V, V_{DS}=30V, I_D=1A$	-	1.7	-	nC
Gate-Source Charge	Q_{gs}		-	0.57	-	
Gate-Drain Charge	Q_{gd}		-	0.3	-	
Reverse Recovery Charge	Q_{rr}	$I_f=1A, di/dt=100A/us$	-	4	-	nC
Reverse Recovery Time	t_{rr}		-	14	-	ns
Turn-on Delay Time	$t_{D(on)}$	$V_{GS}=10V, V_{DD}=30V, I_D=1A$ $R_{GEN}=3$	-	4	-	ns
Turn-on Rise Time	t_r		-	19	-	
Turn-off Delay Time	$t_{D(off)}$		-	12	-	
Turn-off fall Time	t_f		-	24	-	

A. Repetitive rating; pulse width limited by max. junction temperature.

B. P_d is based on max. junction temperature, using junction-case thermal resistance.

C. The value of R_{JA} is measured with the device mounted on 1 in² FR-4 board with 2oz. Copper, in the still air environment with $T_A=25$. The maximum allowed junction temperature of 150. The value in any given application depends on the user's specific board design.



Typical Electrical and Thermal Characteristics Diagrams

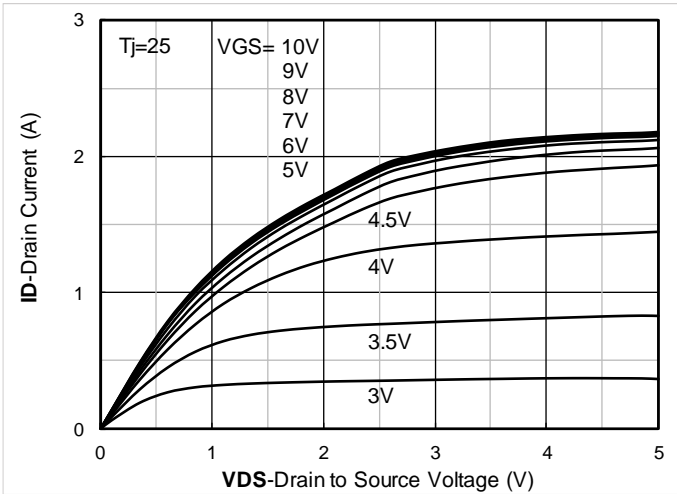

Figure 1. Output Characteristics

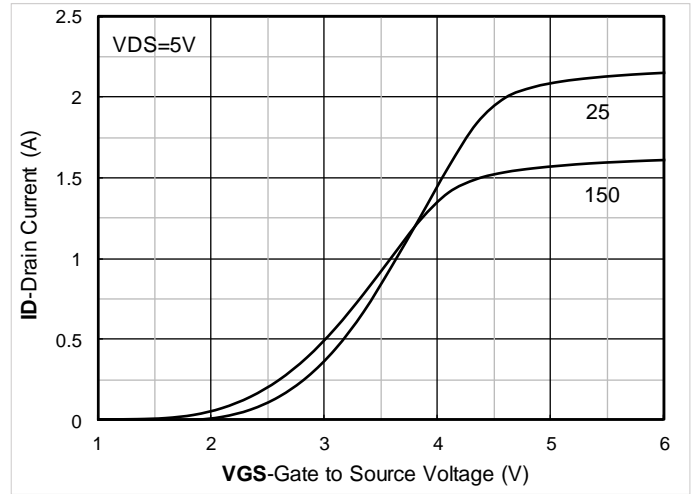

Figure 2. Transfer Characteristics

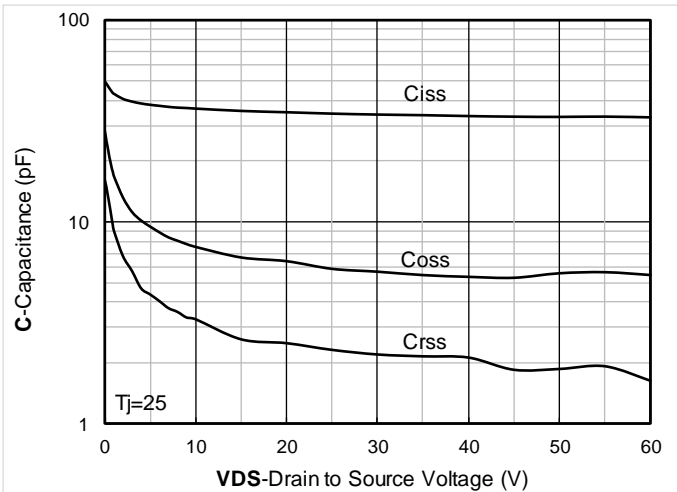

Figure 3. Capacitance Characteristics

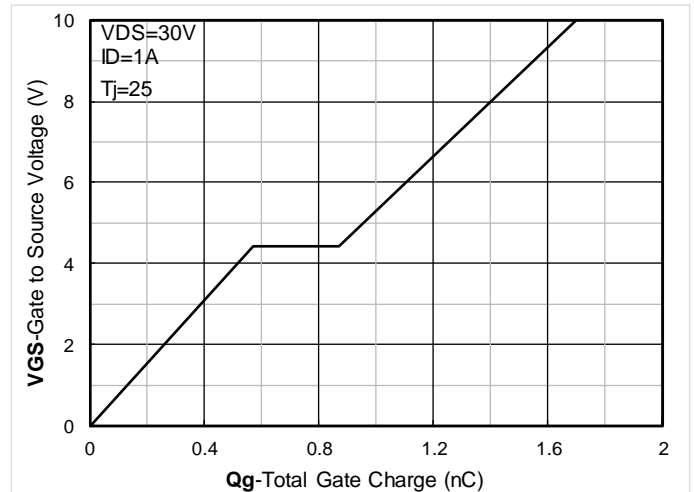

Figure 4. Gate Charge

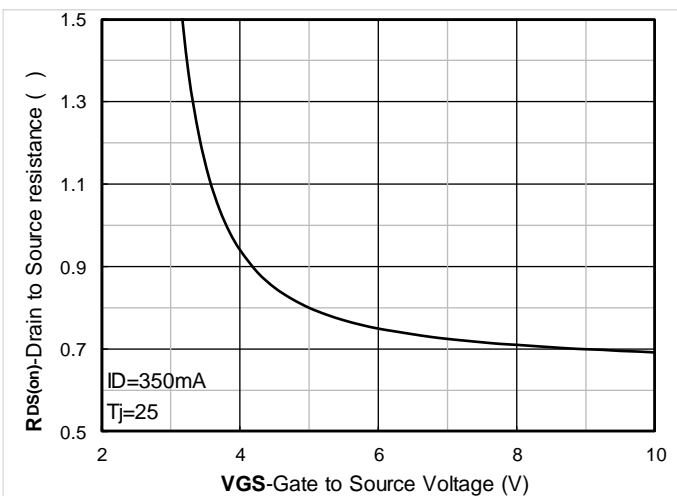

Figure 5. On-Resistance vs Gate to Source Voltage

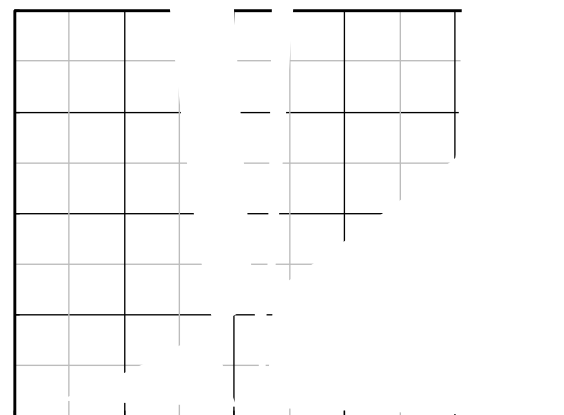

Figure 6. Normalized On-Resistance



2N7002C

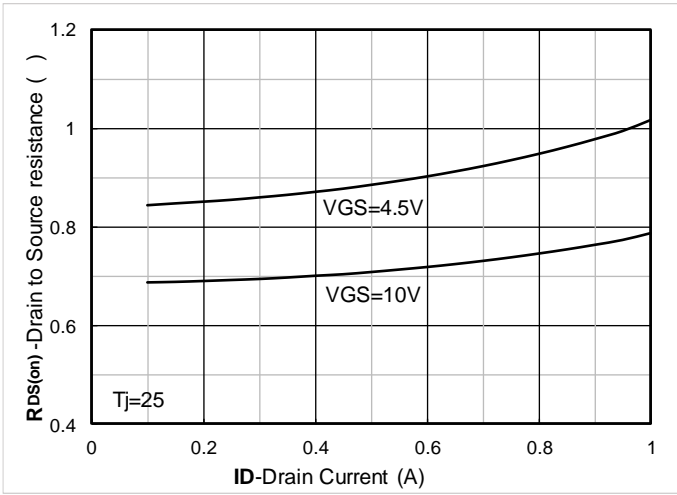

Figure 7. $R_{DS(on)}$ VS Drain Current

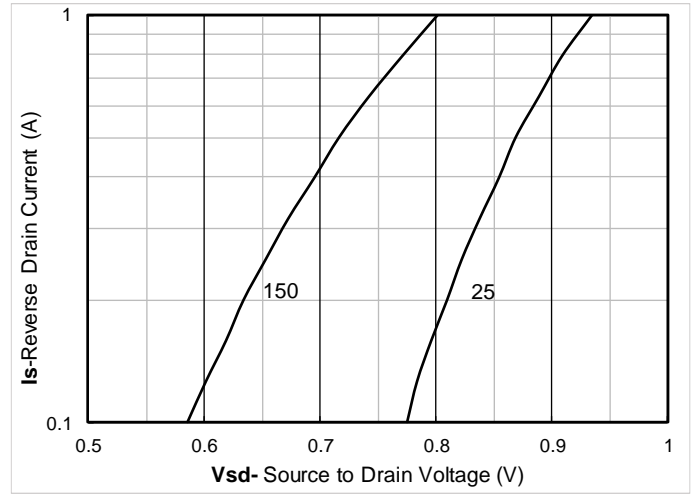

Figure 8. Forward characteristics of reverse diode

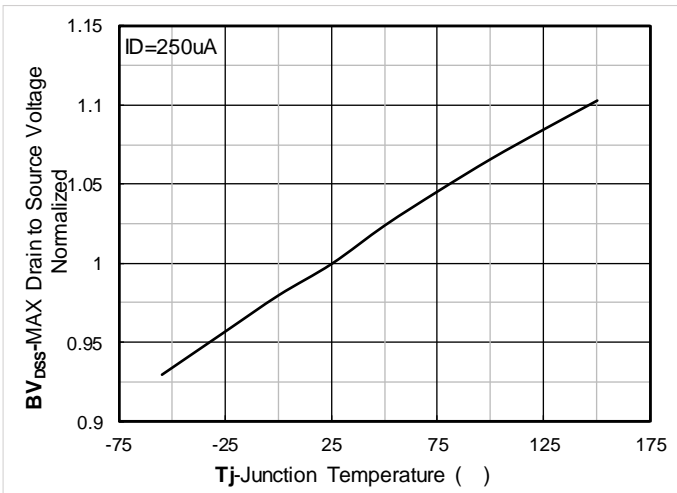

Figure 9. Normalized breakdown voltage

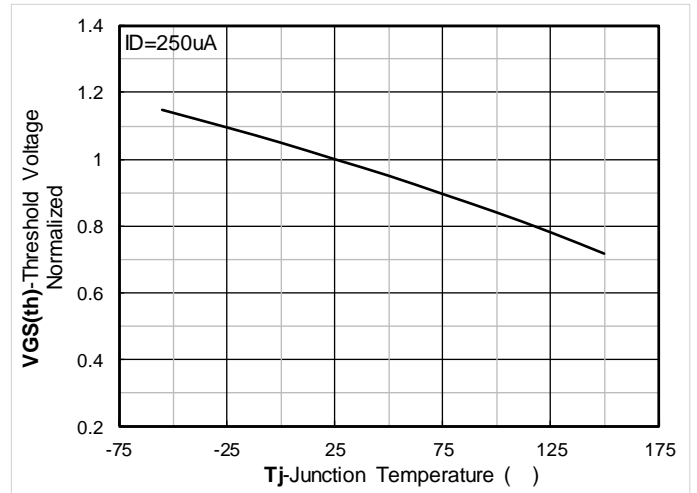

Figure 10. Normalized Threshold voltage

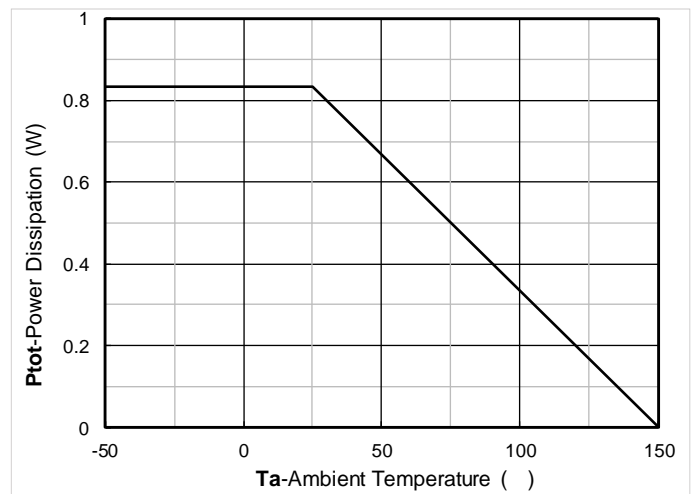

Figure 11. Current dissipation

Figure 12. Power dissipation

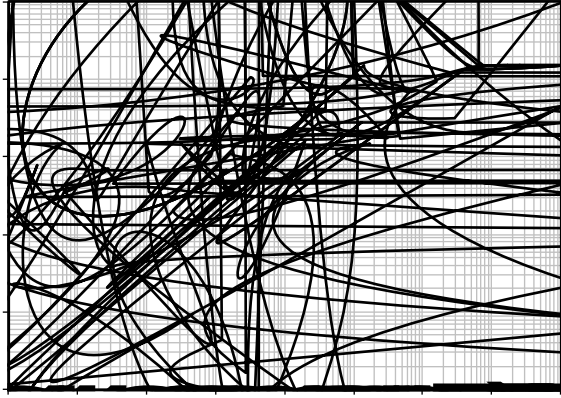

Figure 13. Maximum Transient Thermal Impedance

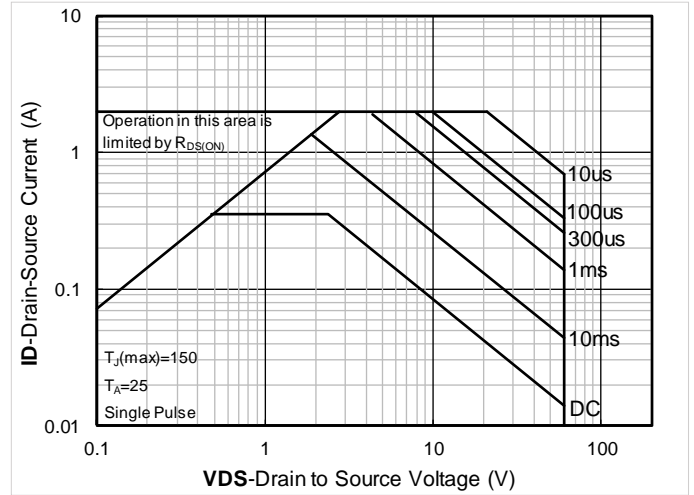

Figure 14. Safe Operation Area

Test Circuits & Waveforms

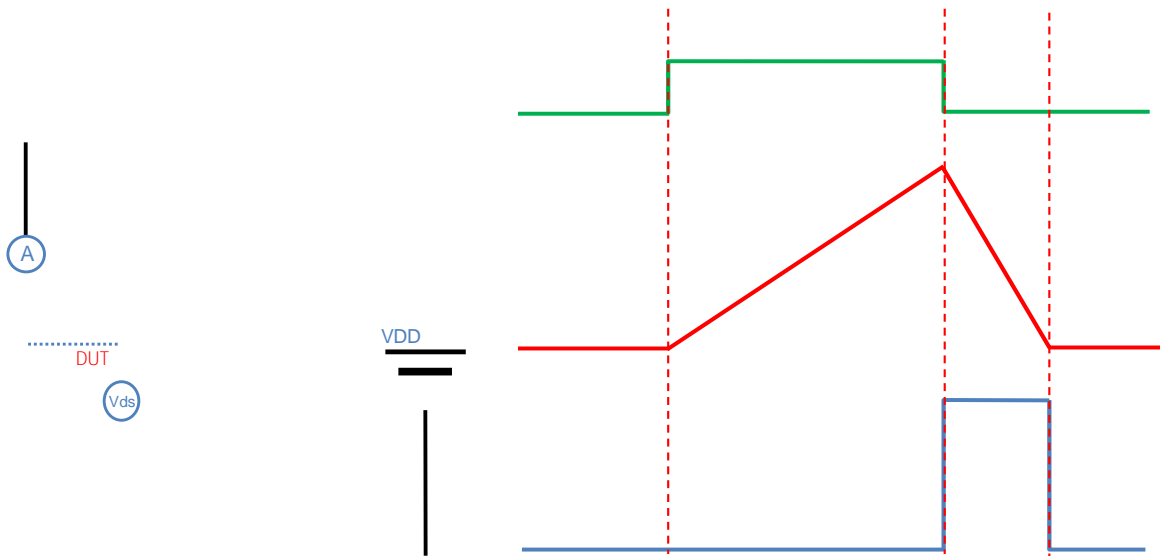

Figure A. Unclamped Inductive Switching (UIS) Test Circuit & Waveform

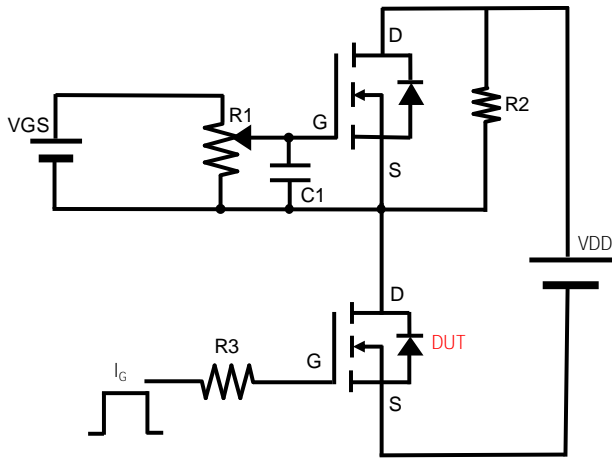

Figure B. Gate Charge Test Circuit & Waveform

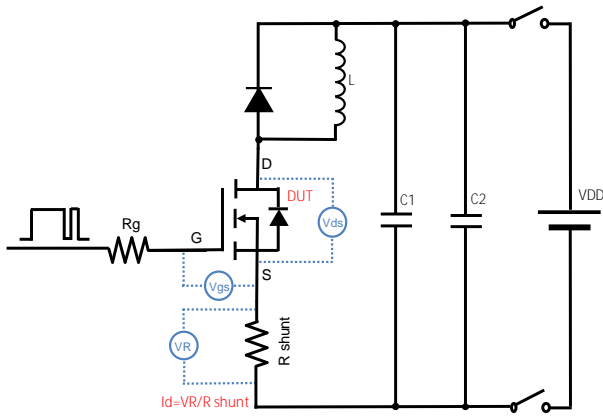

Figure C. Resistive Switching Test Circuit & Waveform

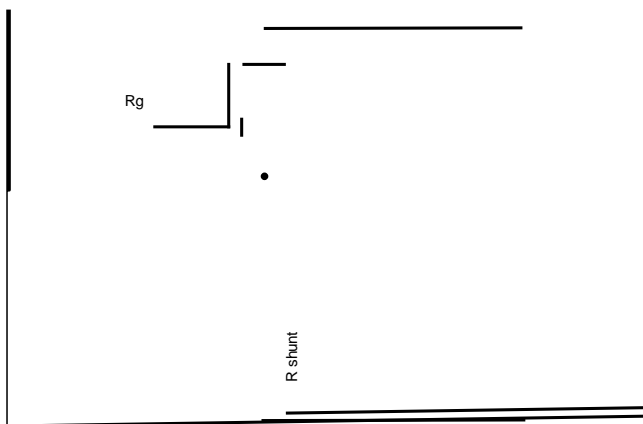
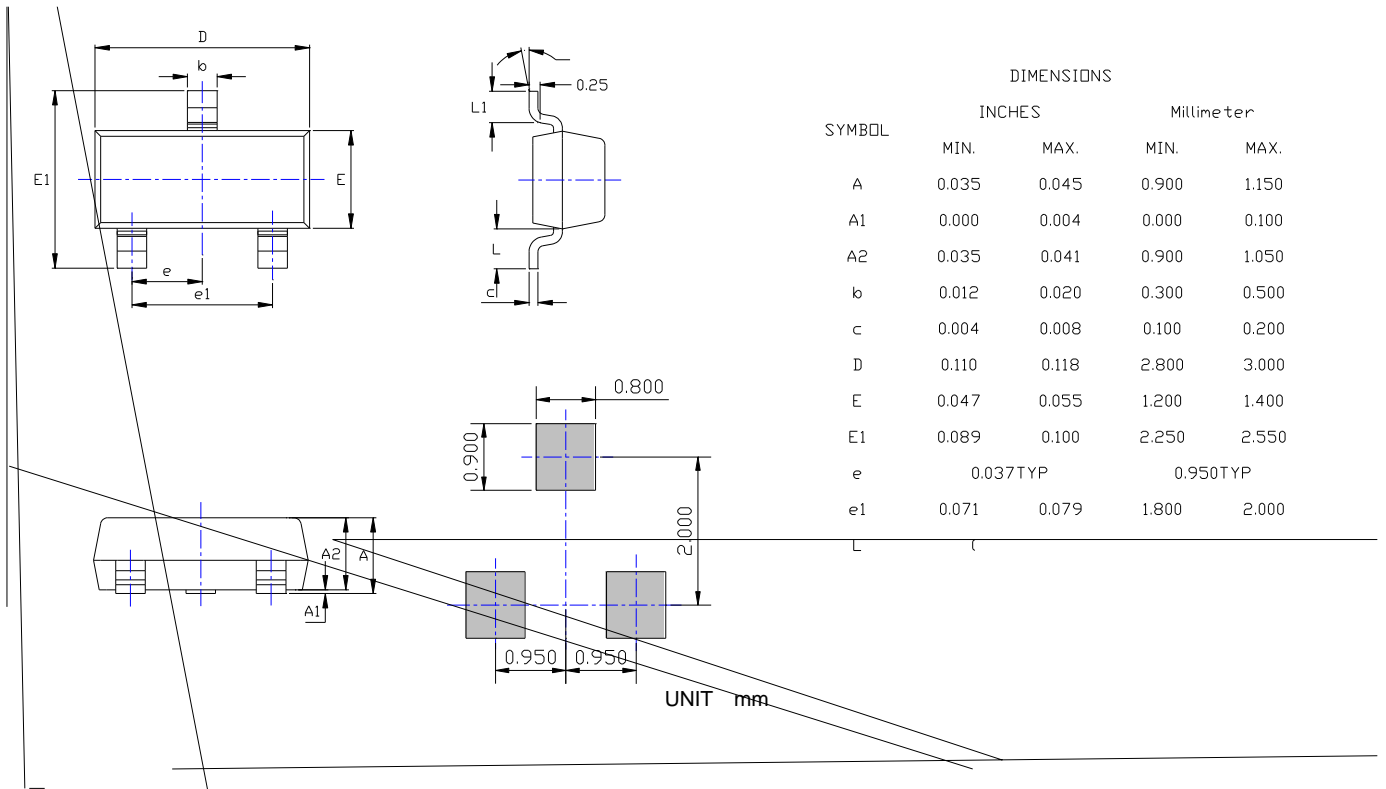

Figure D. Diode Recovery Test Circuit & Waveform



2N7002C

SOT-23 Package information





2N7002C

Disclaimer

The information presented in this document is for reference only. Yangzhou Yangjie Electronic Technology Co., Ltd. reserves the right to make changes without notice for the specification of the products displayed herein to improve reliability, function or design or otherwise.

The product listed herein is designed to be used with ordinary electronic equipment or devices, and not designed to be used with equipment or devices which require high level of reliability and the malfunction of which would directly endanger human life (such as medical instruments, transportation equipment, aerospace machinery, nuclear-reactor controllers, fuel controllers and other safety devices), Yangjie or anyone on its behalf, assumes no responsibility or liability for any damages resulting from such improper use of sale.

This publication supersedes & replaces all information previously supplied. For additional information, please visit our website <http://www.21yangjie.com> , or consult your nearest Yangjie's sales office for further assistance.