

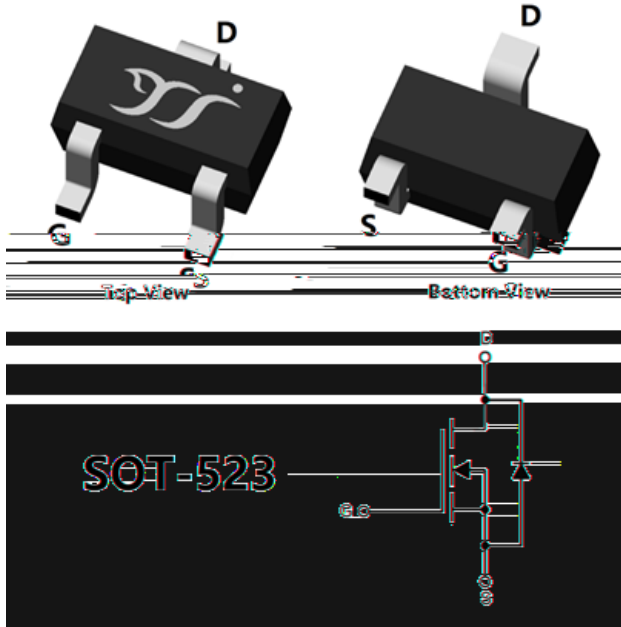

# BSS138BE

## N-Channel Enhancement Mode Field Effect Transistor



### Product Summary

$V_{DS}$	50V
$I_D$	300mA
$R_{DS(ON)}$ (at $V_{GS}=10V$ )	1100m
$R_{DS(ON)}$ (at $V_{GS}=4.5V$ )	1200m

### General Description

Trench Power MV MOSFET technology  
 Voltage controlled small signal switch  
 Low input Capacitance  
 Fast Switching Speed  
 Low Input / Output Leakage  
 Moisture Sensitivity Level 1  
 Epoxy Meets UL 94 V-0 Flammability Rating  
 Halogen Free

### Applications

Battery operated systems  
 Solid-state relays  
 Direct logic-level interface TTL/CMOS

### Absolute Maximum Ratings ( $T_A=25$ unless otherwise noted)

Parameter		Symbol	Limit	Unit
Drain-source Voltage		$V_{DS}$	50	V
Gate-source Voltage		$V_{GS}$	$\pm 20$	V
Drain Current	$T_A=25^\circ C$	$I_D$	300	mA
	$T_A=100^\circ C$		189	
Pulsed Drain Current <sup>A</sup>		$I_{DM}$	2	A
Total Power Dissipation <sup>B</sup>	$T_A=25^\circ C$	$P_D$	290	mW
	$T_A=100^\circ C$		116	
Junction and Storage Temperature Range		$T_J, T_{STG}$	-55 +150	$^\circ C$

### Thermal resistance

Parameter		Symbol	Typ	Max	Units
Thermal Resistance Junction-to-Ambient <sup>C</sup>	Steady-State	$R_{JA}$	360	430	$^\circ C/W$

### Ordering Information (Example)

PREFERRED P/N	PACKING CODE	Marking	MINIMUM PACKAGE(pcs)	INNER BOX QUANTITY(pcs)	OUTER CARTON QUANTITY(pcs)	DELIVERY MODE
BSS138BE	F2	138	3000	30000	120000	7" reel



# BSS138BE

## Electrical Characteristics ( $T_J=25$ unless otherwise noted)

Parameter	Symbol	Conditions	Min	Typ	Max	Units
<b>Static Parameter</b>						
Drain-Source Breakdown Voltage	$BV_{DSS}$	$V_{GS}=0V, I_D=250\mu A$	50	-	-	V
Zero Gate Voltage Drain Current	$I_{DSS}$	$V_{DS}=50V, V_{GS}=0V$	-	-	1	$\mu A$
		$V_{DS}=50V, V_{GS}=0V, T_J=150^\circ C$	-	-	100	
Gate-Body Leakage Current	$I_{GSS}$	$V_{GS}=\pm 20V, V_{DS}=0V$	-	-	$\pm 100$	nA
Gate Threshold Voltage	$V_{GS(th)}$	$V_{DS}=V_{GS}, I_D=250\mu A$	0.8	1.2	1.6	V
Static Drain-Source On-Resistance	$R_{DS(on)}$	$V_{GS}=10V, I_D=300mA$	-	670	1100	$\Omega$



# BSS138BE

## Typical Electrical and Thermal Characteristics Diagrams

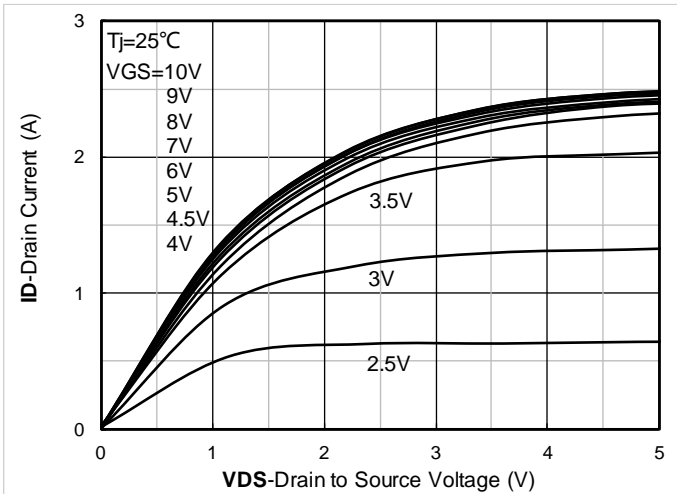

Figure 1. Output Characteristics

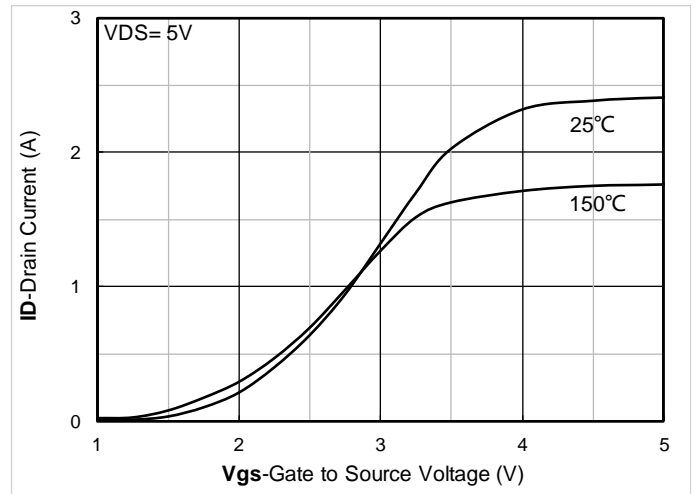

Figure 2. Transfer Characteristics

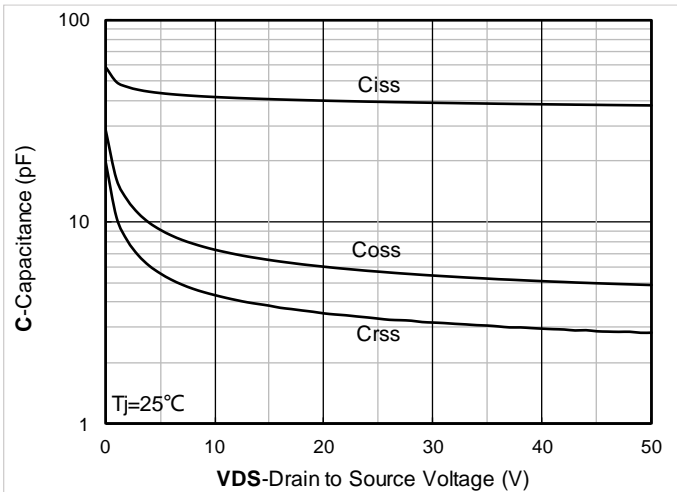

Figure 3. Capacitance Characteristics

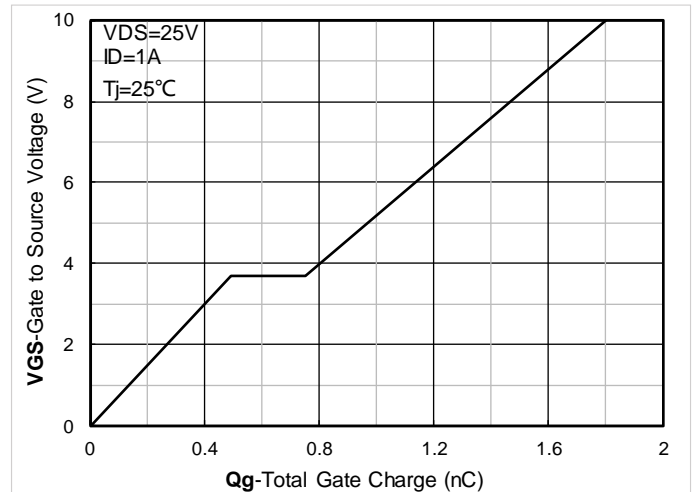

Figure 4. Gate Charge

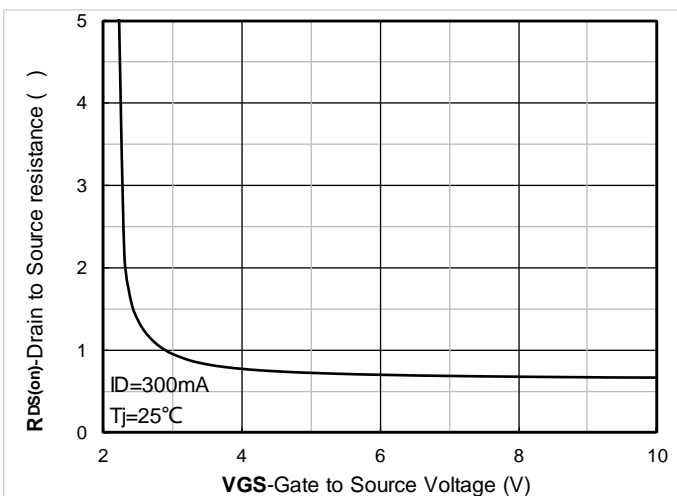

Figure 5. On-Resistance vs Gate to Source Voltage

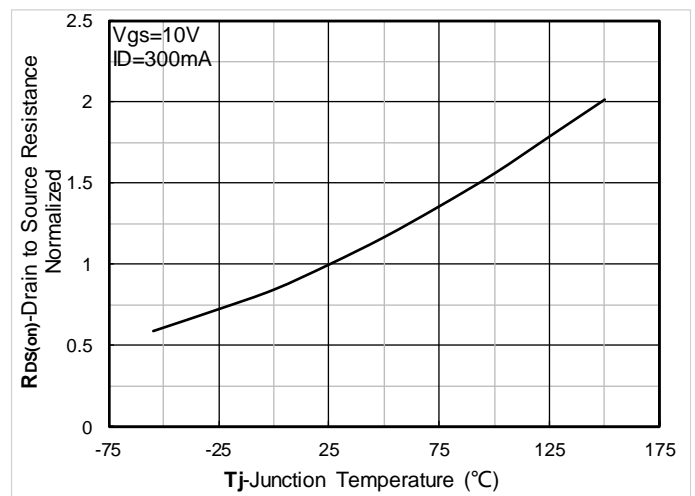

Figure 6. Normalized On-Resistance



# BSS138BE

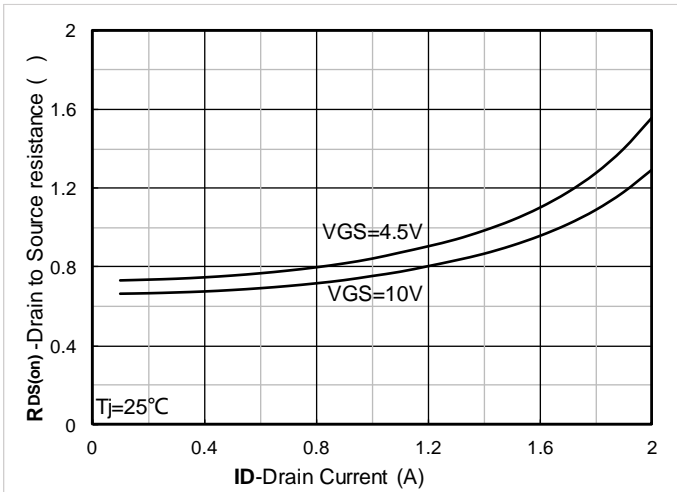

Figure 7.  $R_{DS(on)}$  VS Drain Current

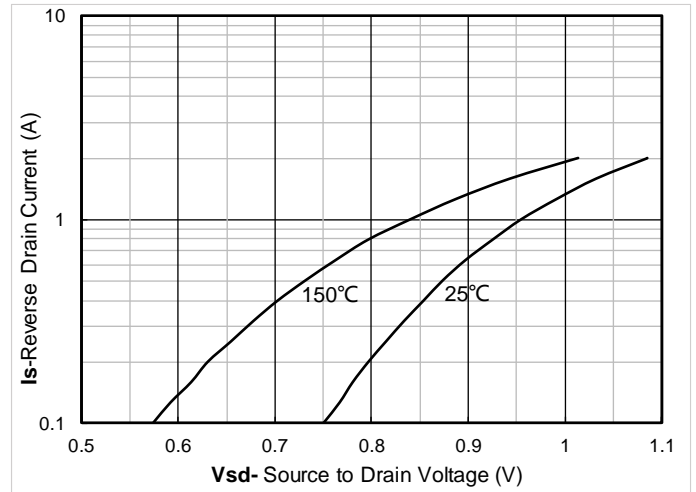

Figure 8. Forward characteristics of reverse diode

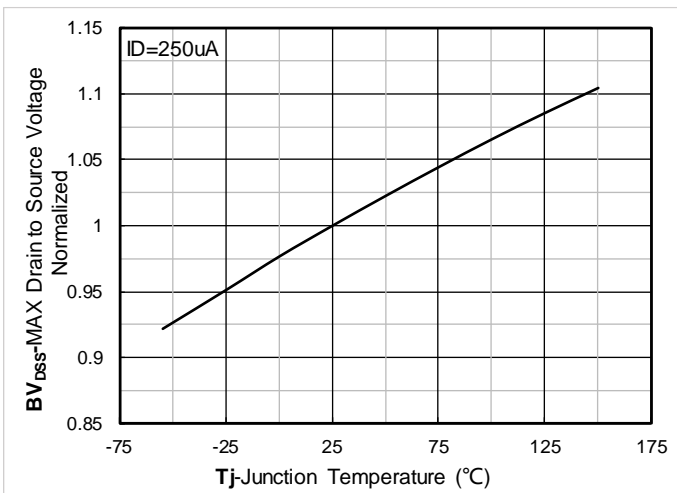

Figure 9. Normalized breakdown voltage

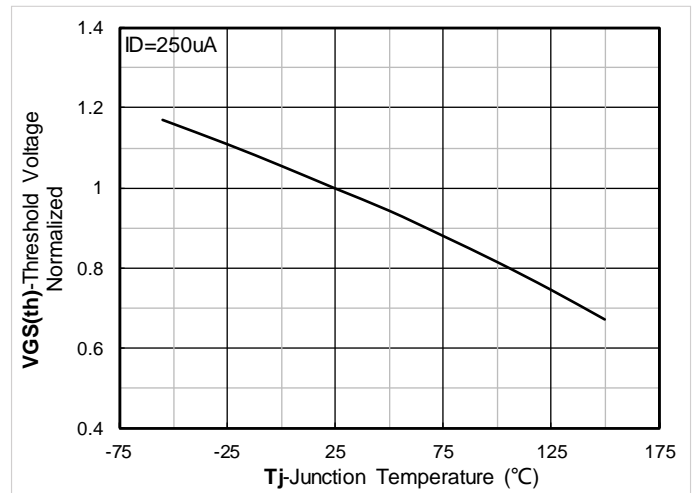

Figure 10. Normalized Threshold voltage

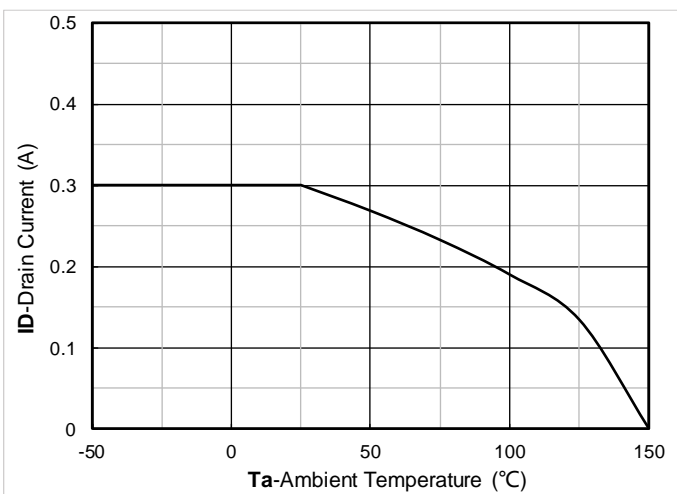

Figure 11. Current dissipation

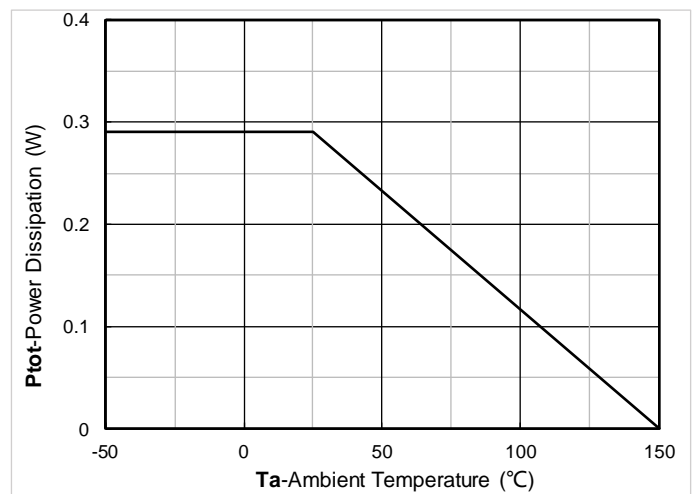

Figure 12. Power dissipation

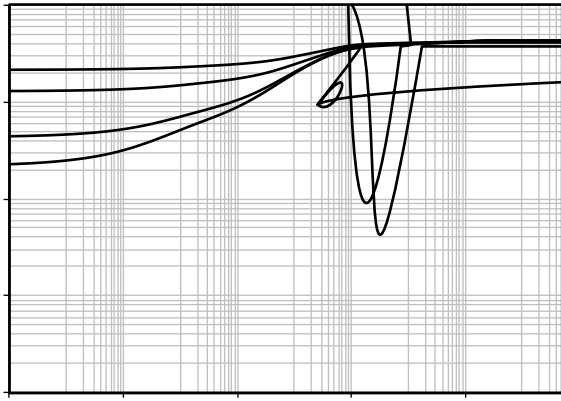

Figure 13. Maximum Transient Thermal Impedance

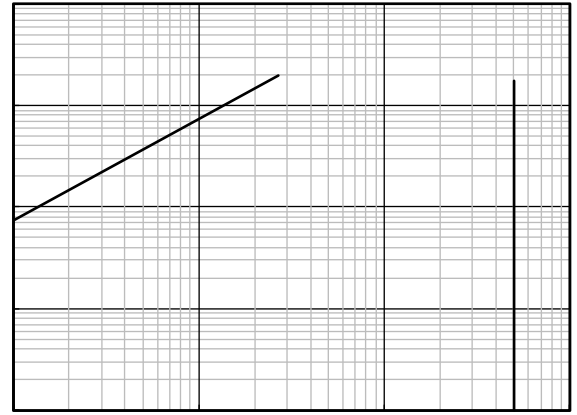

Figure 14. Safe Operation Area

## Test Circuits & Waveforms

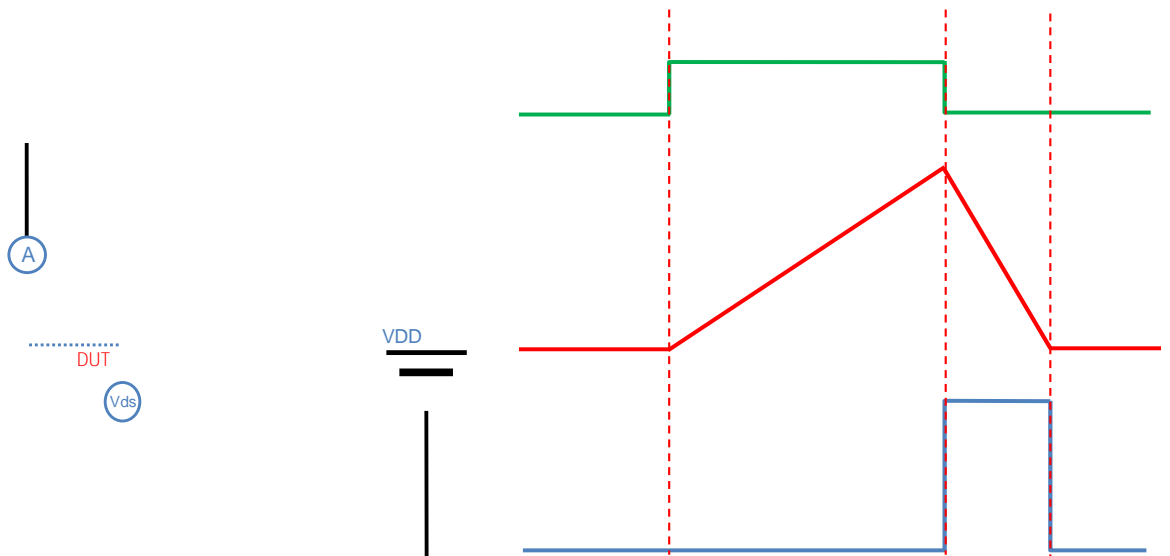

Figure A. Unclamped Inductive Switching (UIS) Test Circuit & Waveform



# BSS138BE

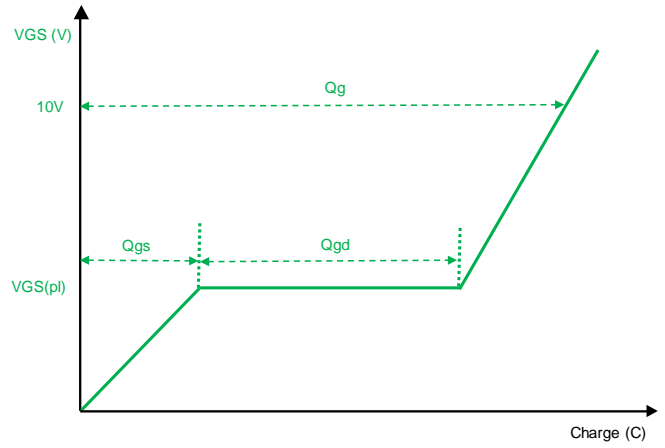
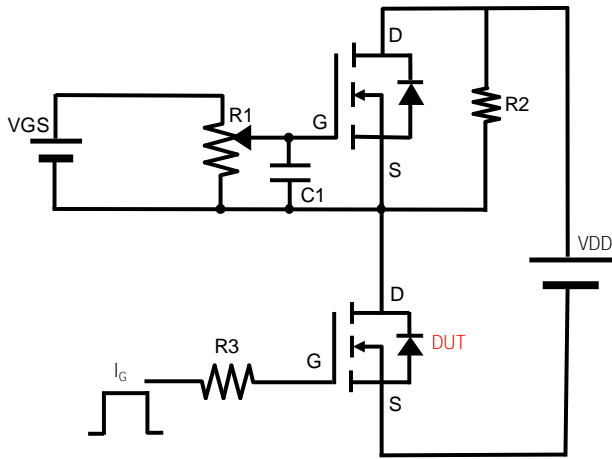

Figure B. Gate Charge Test Circuit & Waveform

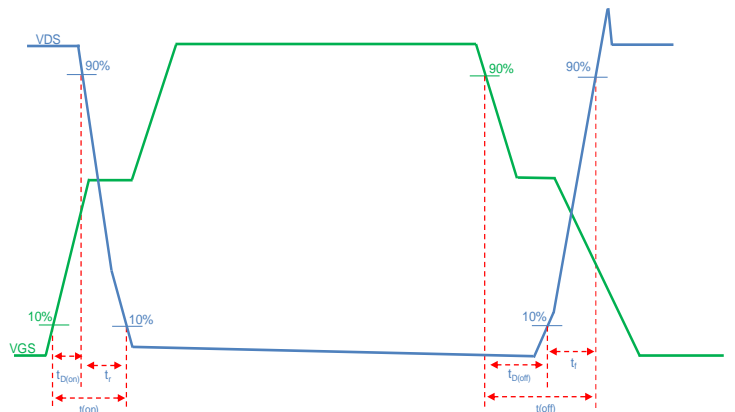
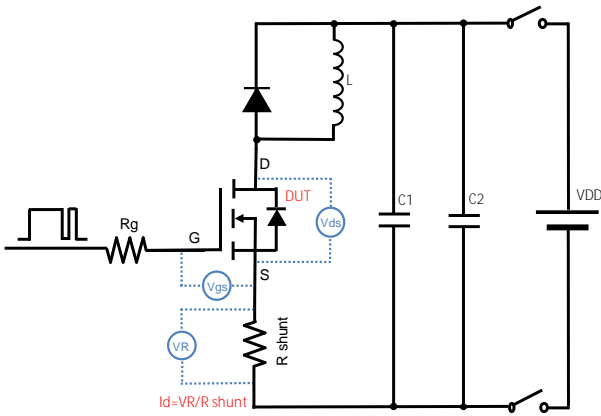

Figure C. Resistive Switching Test Circuit & Waveform

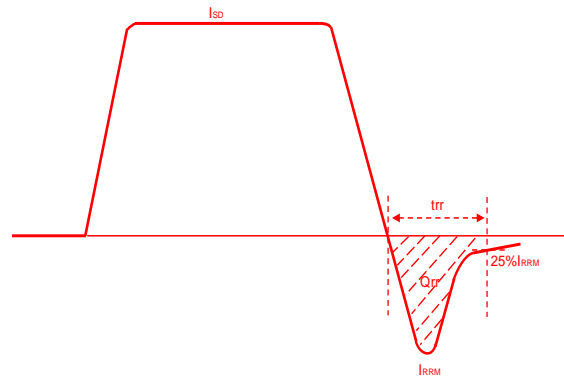
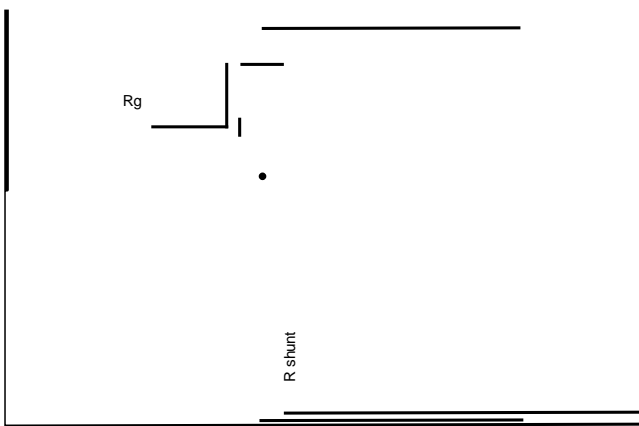

Figure D. Diode Recovery Test Circuit & Waveform



**SOT-523**



## BSS138BE

---

### Disclaimer

The information presented in this document is for reference only. Yangzhou Yangjie Electronic Technology Co., Ltd. reserves the right to make changes without notice for the specification of the products displayed herein to improve reliability, function or design or otherwise.

The product listed herein is designed to be used with ordinary electronic equipment or devices, and not designed to be used with equipment or devices which require high level of reliability and the malfunction of which would directly endanger human life (such as medical instruments, transportation equipment, aerospace machinery, nuclear-reactor controllers, fuel controllers and other safety devices), Yangjie or anyone on its behalf, assumes no responsibility or liability for any damages resulting from such improper use of sale.

This publication supersedes & replaces all information previously supplied. For additional information, please visit our website <http://www.21yangjie.com> , or consult your nearest Yangjie's sales office for further assistance.