



**YJD75G10A**

---

# **N-Channel Enhancement Mode Field Effect Transistor**

**Product Summary**

**General Description**

**Applications**

---





# YJD75G10A

---

## Electrical Characteristics

Parameter	Symbol	Conditions	Min	Typ	Max	Units
-----------	--------	------------	-----	-----	-----	-------

---





# YJD75G10A

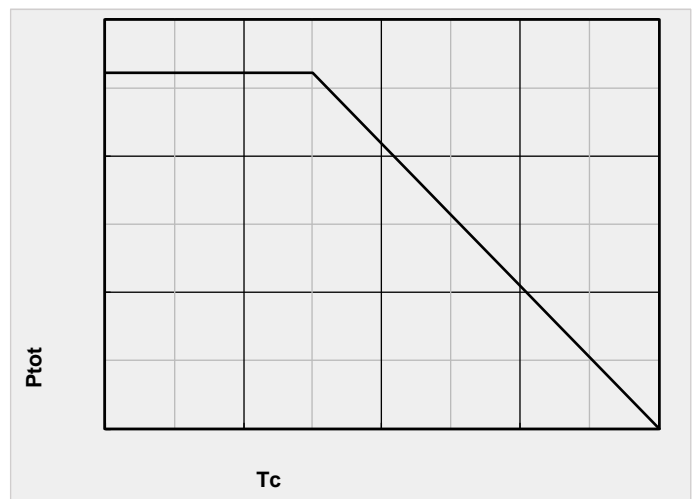
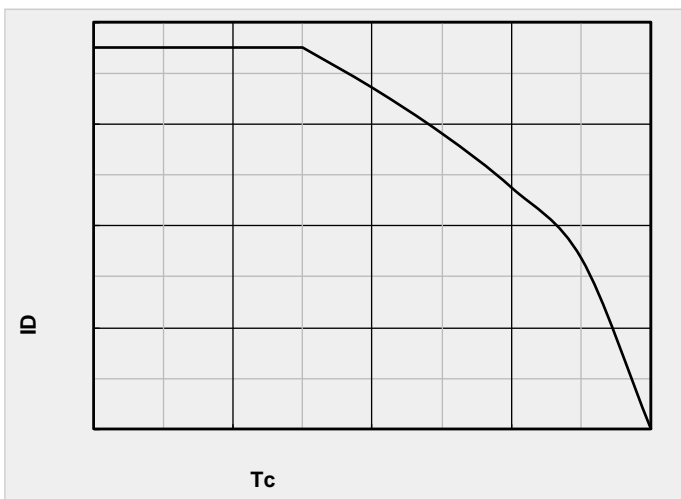
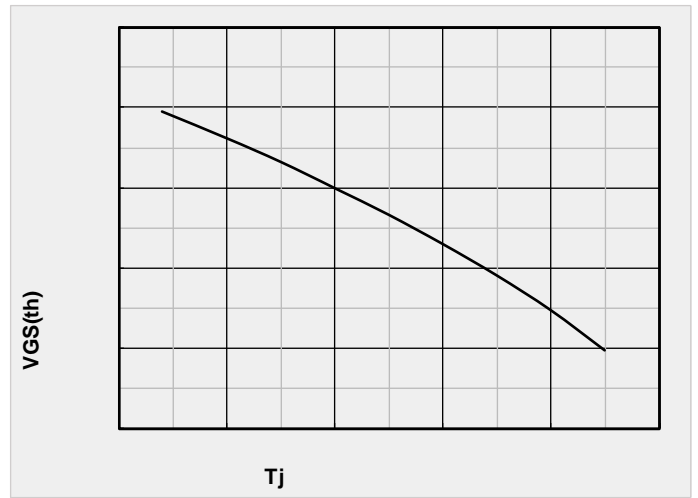
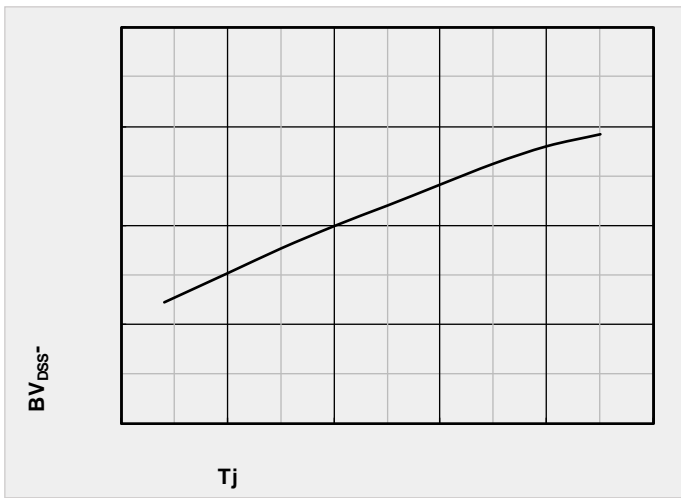
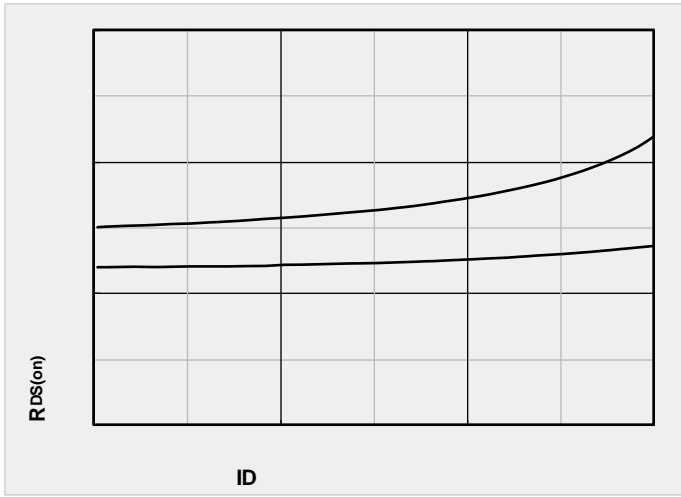



# YJD75G10A

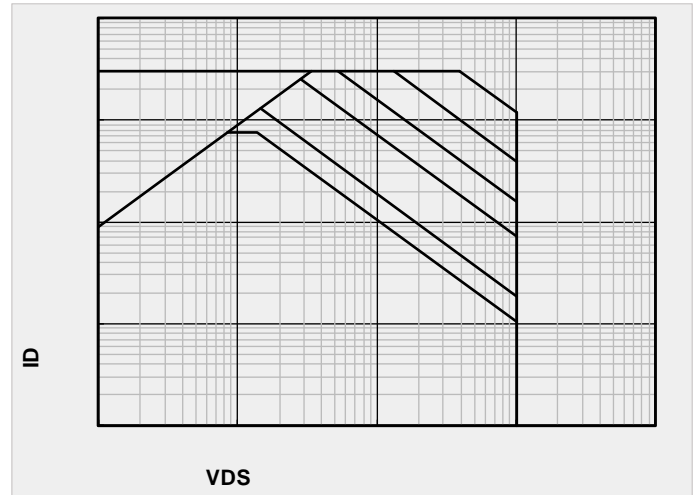
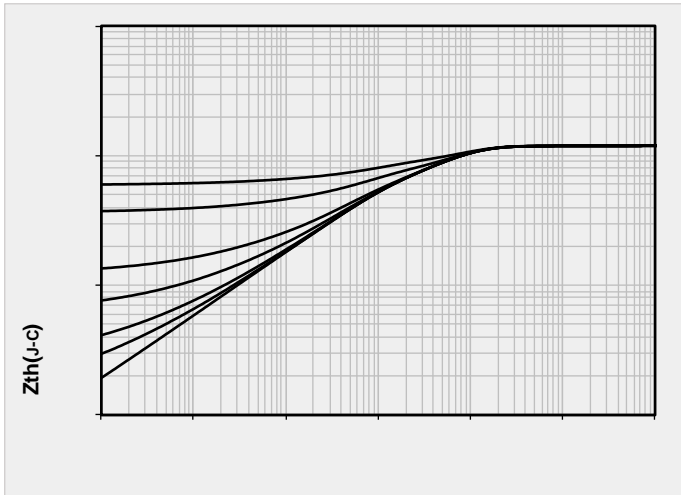

## Test Circuits & Waveforms

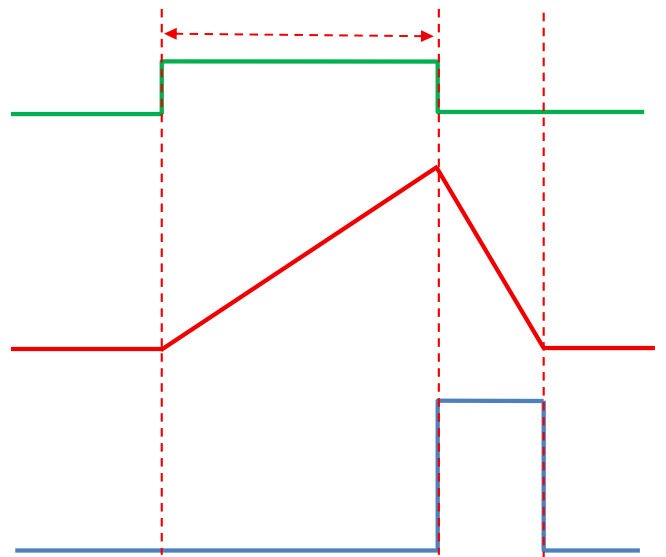
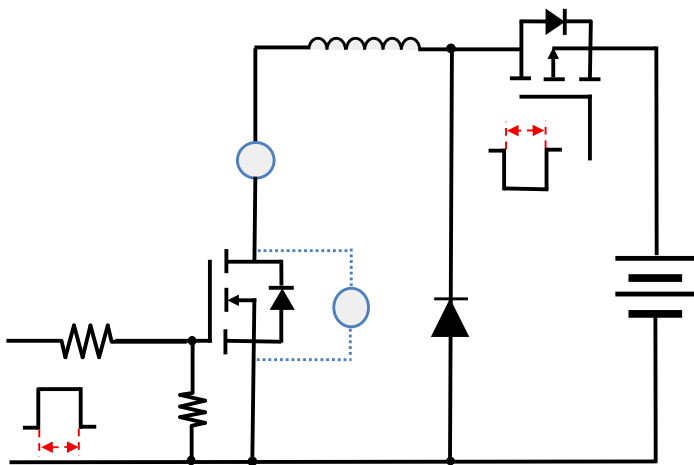

**YJD75G10A**

---

**YJD75G10A**

---



**YJD75G10A**

---

**Disclaimer**

---

---