



YJG75G15H

Electrical Characteristics (T_J=25 unless otherwise noted)

Parameter	Symbol	Conditions	Min	Typ	Max	Units
Static Parameter						
Drain-Source Breakdown Voltage	BV _{DSS}	V _{GS} = 0V, I _D =250μA	150	-	-	V
Zero Gate Voltage Drain Current	I _{DSS}	V _{DS} =150V, V _{GS} =0V	-	-	1	μA
		V _{DS} =150V, V _{GS} =0V, T _J =150°C	-	-	100	
Gate-Body Leakage Current	I _{GSS}	V _{GS} = ±20V, V _{DS} =0V	-	-	±100	nA
Gate Threshold Voltage	V _{GS(th)}	V _{DS} = V _{GS} , I _D =250μA	2	3	4	V
Static Drain-Source On-Resistance	R _{DS(on)}	V _{GS} =10V, I _D =37.5A	-	9.2	11.8	m
		V _{GS} =10V, I _D =20A	-	9.2	11.8	
Diode Forward Voltage	V _{SD}	I _S =37.5A, V _{GS} =0V	-	-	1.2	V
Gate resistance	R _G	f=1MHz	-	1	-	
Maximum Body-Diode Continuous Current	I _S		-	-	75	A
Dynamic Parameters						
Input Capacitance	C _{iss}	V _{DS} =75V, V _{GS} =0V, f=1MHz	-	3750	-	pF
Output Capacitance	C _{oss}		-	290	-	
Reverse Transfer Capacitance	C _{rss}		-	6	-	
Switching Parameters						
Total Gate Charge	Q _g	V _{GS} =10V, V _{DS} =75V, I _D =37.5A	-	48	-	nC
Gate-Source Charge	Q _{gs}		-	16	-	
Gate-Drain Charge	Q _{gd}		-	14	-	
Reverse Recovery Charge	Q _{rr}	I _F =37.5A, di/dt=100A/us	-	245	-	nC
Reverse Recovery Time	t _{rr}		-	87	-	ns
Turn-on Delay Time	t _{D(on)}	V _{GS} =10V, V _{DD} =75V, I _D =37.5A R _{GEN} =2.2	-	19	-	ns
Turn-on Rise Time	t _r		-	109	-	
Turn-off Delay Time	t _{D(off)}		-	31	-	
Turn-off fall Time	t _f		-	6	-	

A. Repetitive rating; pulse width limited by max. junction temperature.

B. T_J=25°C, V_{DD}=75V, V_G=10V, R_G=25 , L=2mH, I_{AS}=19A.

C. P_d is based on max. junction temperature, using junction-case thermal resistance.

D. The value of R_{JA} is measured with the device mounted on 1 in² FR-4 board with 2oz. Copper, in the still air environment with T_A=25°C. The maximum allowed junction temperature of 150°C. The value in any given application depends on the user's specific board design.



YJG75G15H

Typical Electrical and Thermal Characteristics Diagrams

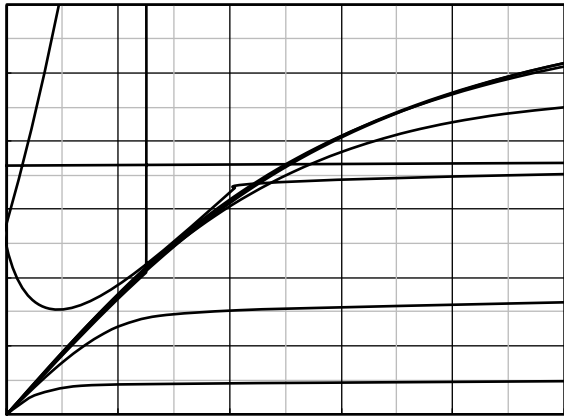

Figure 1. Output Characteristics

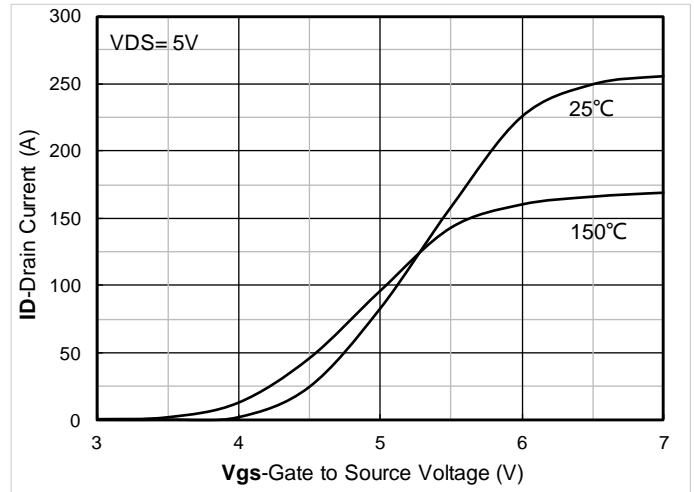

Figure 2. Transfer Characteristics

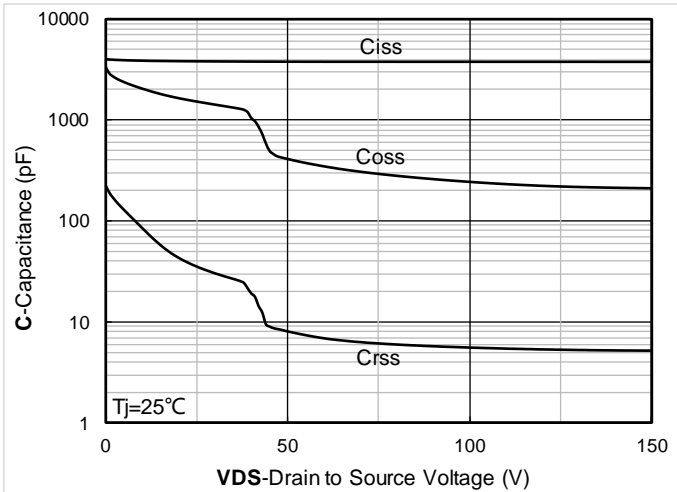

Figure 3. Capacitance Characteristics

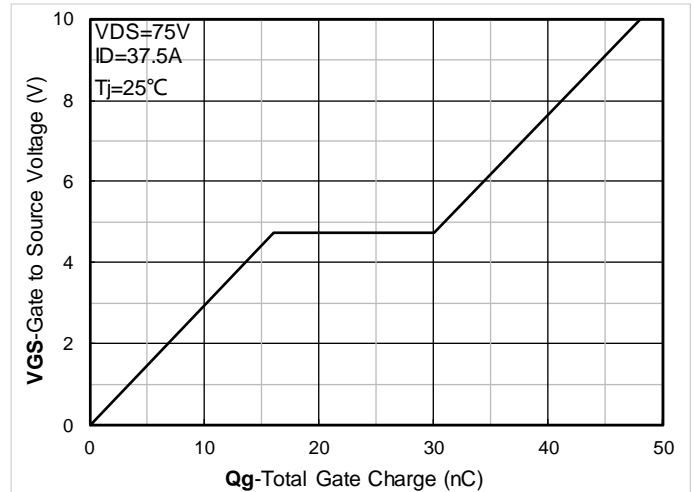

Figure 4. Gate Charge

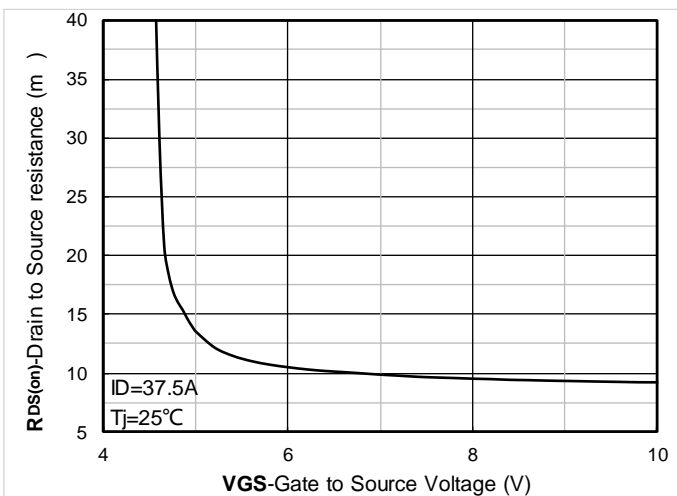

Figure 5. On-Resistance vs Gate to Source Voltage

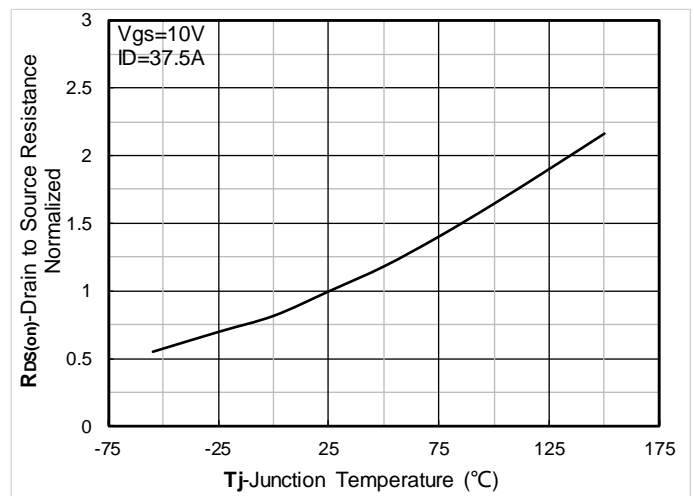

Figure 6. Normalized On-Resistance



YJG75G15H

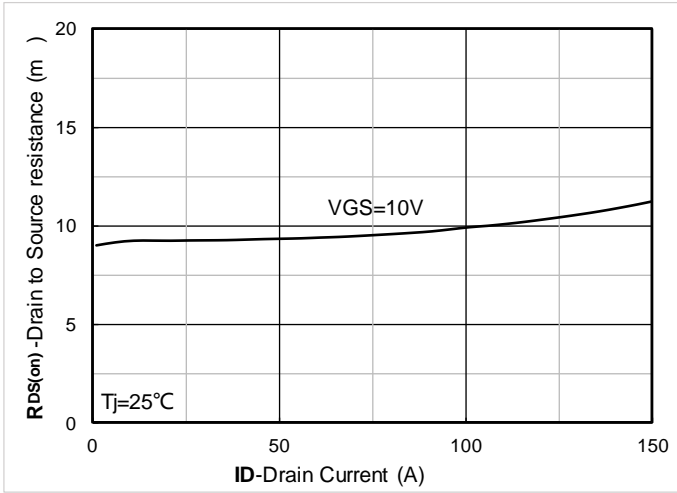

Figure 7. $R_{DS(on)}$ VS Drain Current

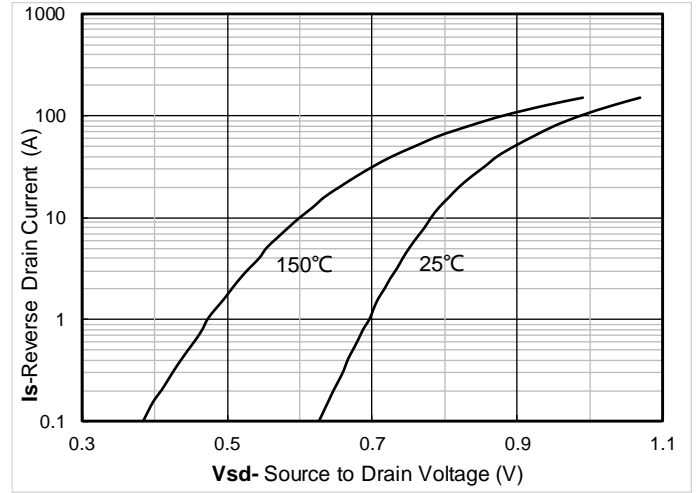

Figure 8. Forward characteristics of reverse diode

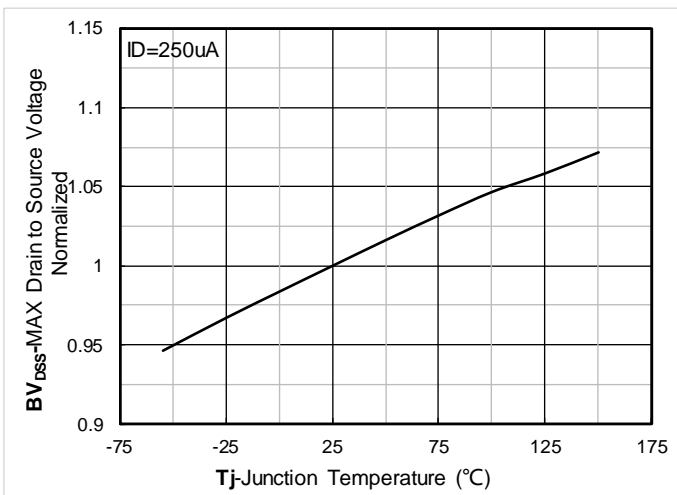

Figure 9. Normalized breakdown voltage

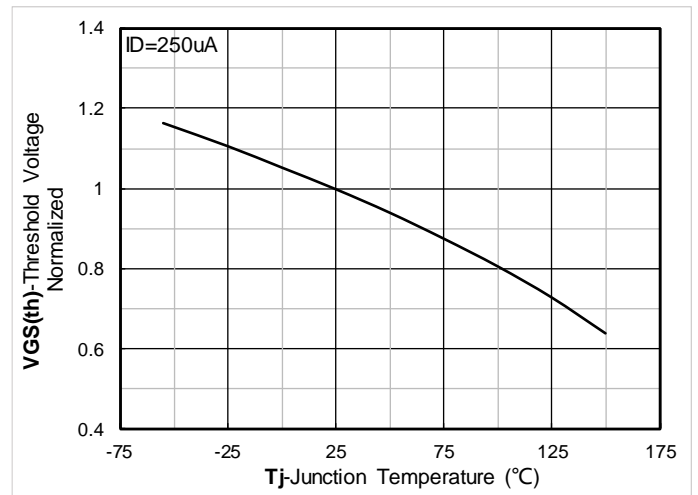

Figure 10. Normalized Threshold voltage

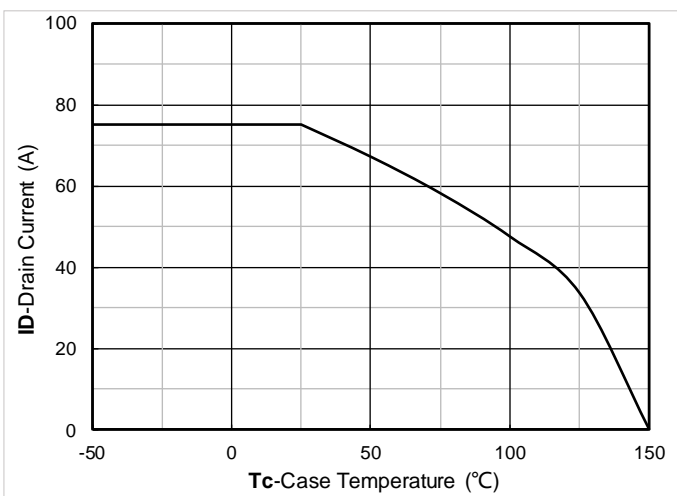

Figure 11. Current dissipation

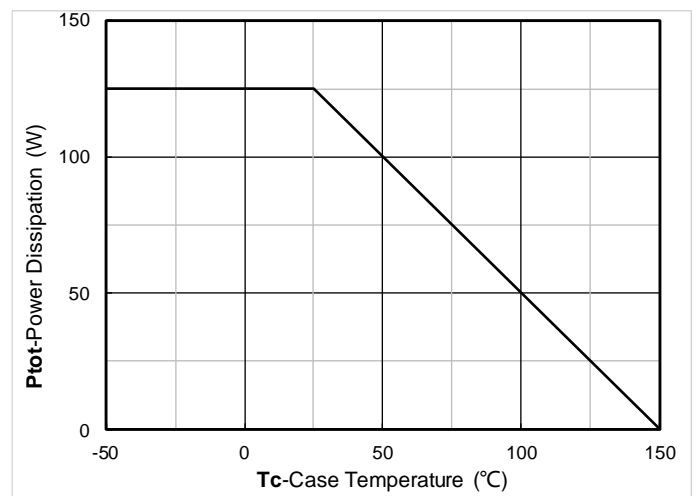

Figure 12. Power dissipation

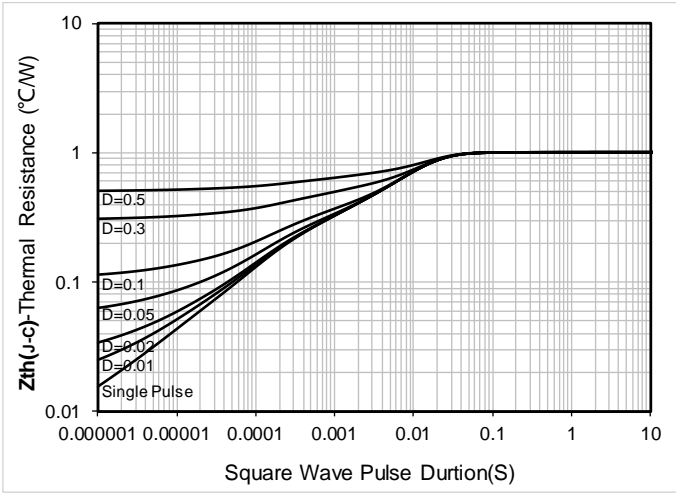

Figure 13. Maximum Transient Thermal Impedance

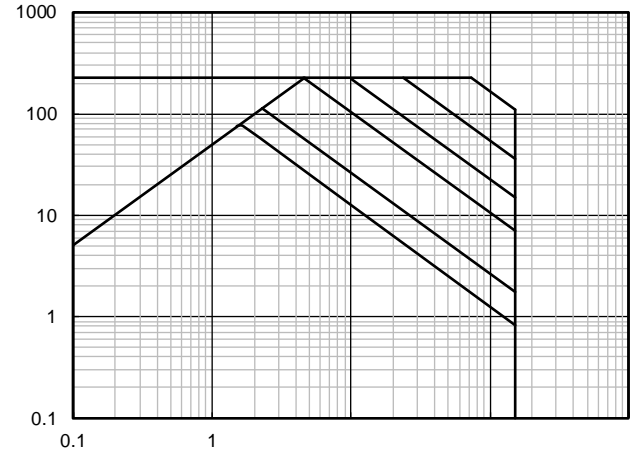

Figure 14. Safe Operation Area

Test Circuits & Waveforms

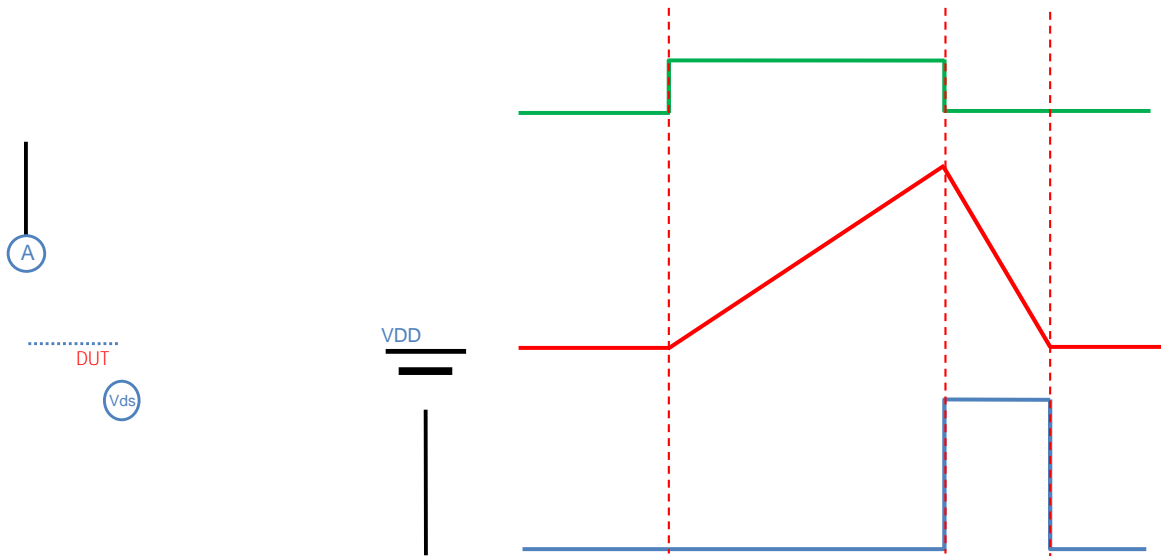

Figure A. Unclamped Inductive Switching (UIS) Test Circuit & Waveform

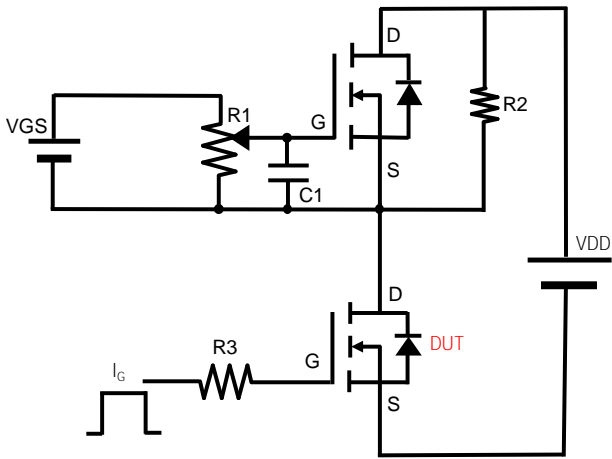

Figure B. Gate Charge Test Circuit & Waveform

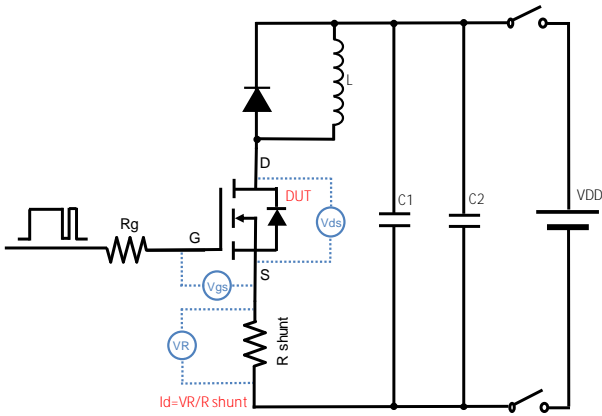

Figure C. Resistive Switching Test Circuit & Waveform

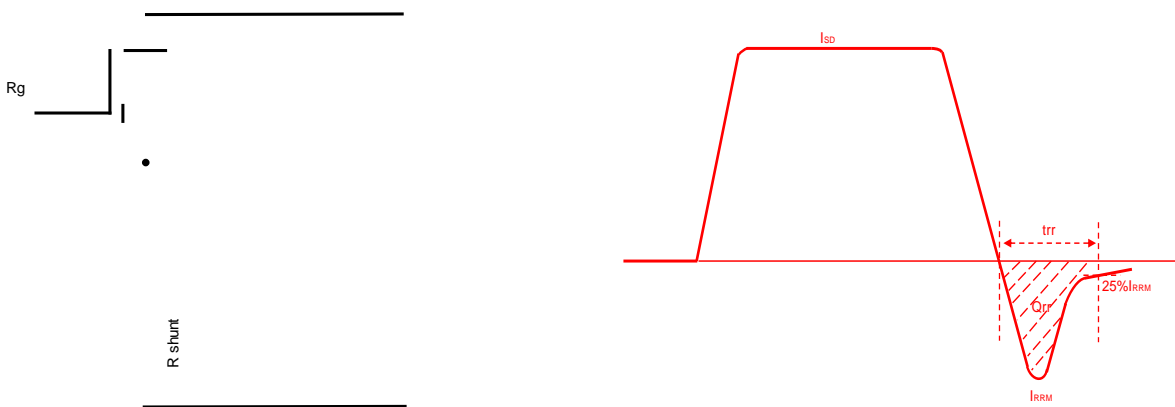
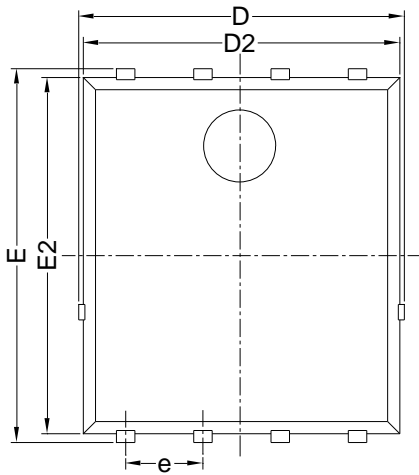

Figure D. Diode Recovery Test Circuit & Waveform



YJG75G15H

PDFN5060-8L-B-1.1MM Package information



Top View

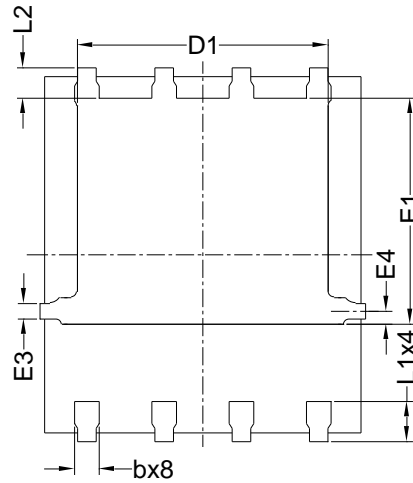

Bottom View

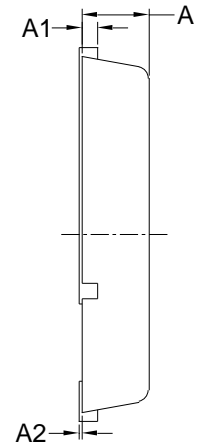

Side View

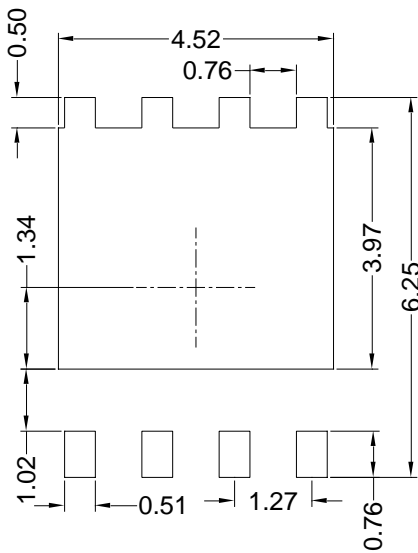

Suggested Solder Pad Layout
Top View

SYMBOL	MILLIMETER		
	MIN	NOM	MAX
D	5.15	5.35	5.55
E	5.95	6.15	6.35
A	1.00	1.10	1.20
A1	0.254 BSC		
A2			0.10
D1	3.92	4.12	4.32
E1	3.52	3.72	3.92
D2	5.00	5.20	5.40
E2	5.66	5.86	6.06
E3	0.254 REF		
E4	0.21 REF		
L1	0.56	0.66	0.76
L2	0.50 BSC		
b	0.31	0.41	0.51
e	1.27 BSC		

Note:

1. Controlling dimension: in millimeters.
2. General tolerance: ± 0.10 mm.
3. The pad layout is for reference purposes only.



YJG75G15H

Disclaimer

The information presented in this document is for reference only. Yangzhou Yangjie Electronic Technology Co., Ltd. reserves the right to make changes without notice for the specification of the products displayed herein to improve reliability, function or design or otherwise.

The product listed herein is designed to be used with ordinary electronic equipment or devices, and not designed to be used with equipment or devices which require high level of reliability and the malfunction of which would directly endanger human life (such as medical instruments, transportation equipment, aerospace machinery, nuclear-reactor controllers, fuel controllers and other safety devices), Yangjie or anyone on its behalf, assumes no responsibility or liability for any damages resulting from such improper use of sale.

This publication supersedes & replaces all information previously supplied. For additional information, please visit our website <http://www.21yangjie.com> , or consult your nearest Yangjie's sales office for further assistance.