

20V
55A
 (at $V_{GS} = 4.5V$) **25mhm**
 (at $V_{GS} = 2.5V$) **32mhm**
 (at $V_{GS} = 1.8V$) **49mhm**

Power LV MOSFET technology
 density cell design for low $R_{DS(on)}$
 speed switching

protection
 switch
 management

Drain-source Voltage	V_{DS}	20	V
Gate-source Voltage	V_{GS}	10	V
Drain Current	I_D	55	A
		44	
Pulsed Drain Current	I_{DM}	22	A
Total Power Dissipation	P_D	11	W
Thermal Resistance	R_{JA}	114	W
Junction and Storage Temperature Range	T_j, T_{STG}	-55 +150	

(Example)





(T_F=25 unless otherwise noted)

Drain Source Breakdown Voltage					V
Zero Gate Voltage Drain Current			1		μA
Gate Body Leakage Current			100		nA
Gate Threshold Voltage			1		V
Static Drain Source On Resistance			25		m
			32		

188 1

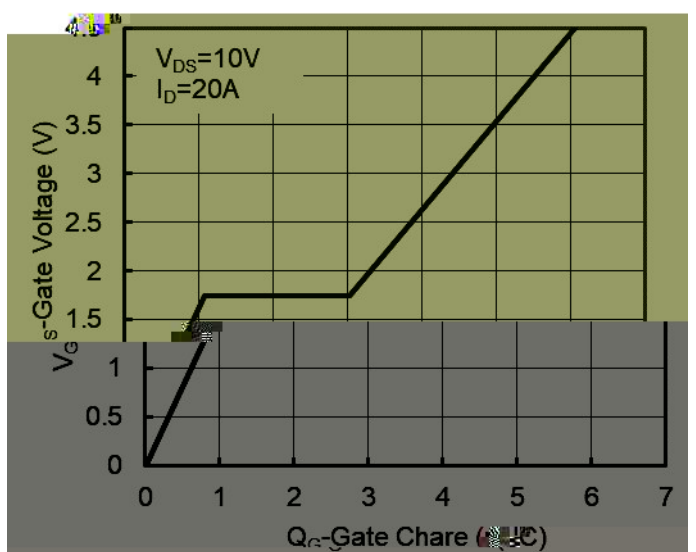
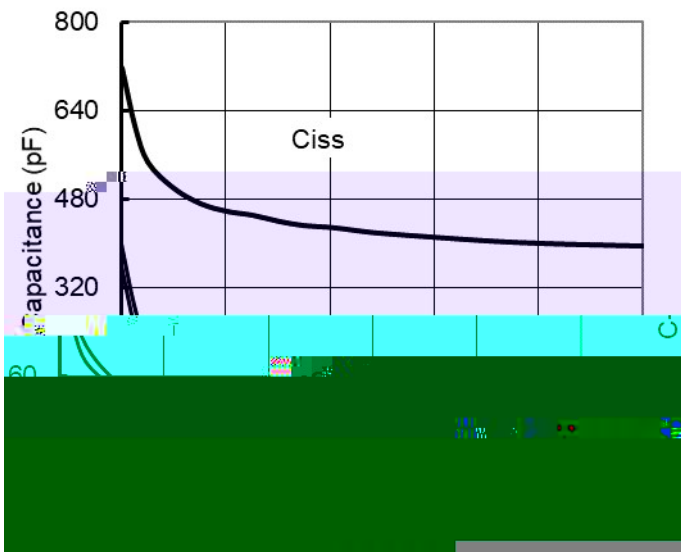
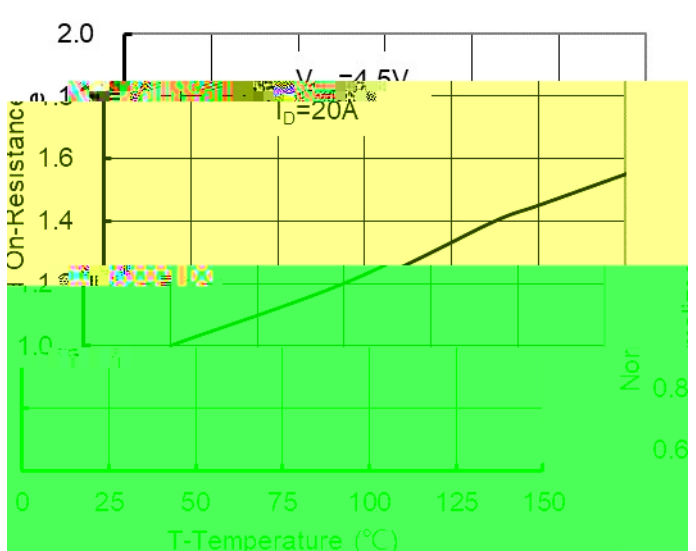
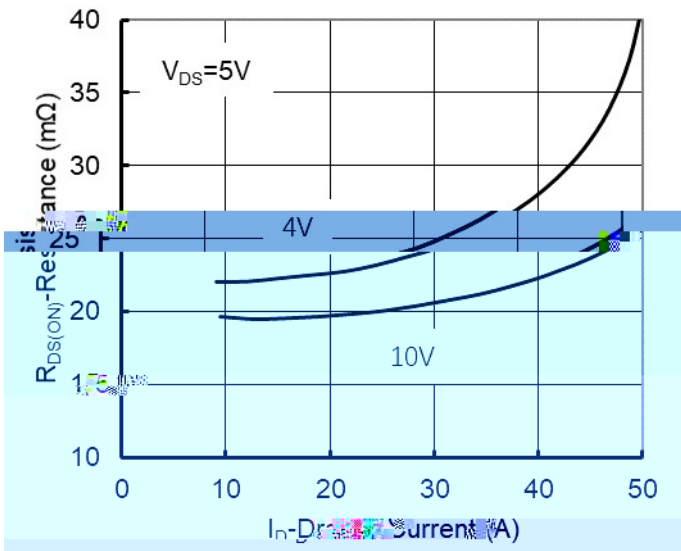
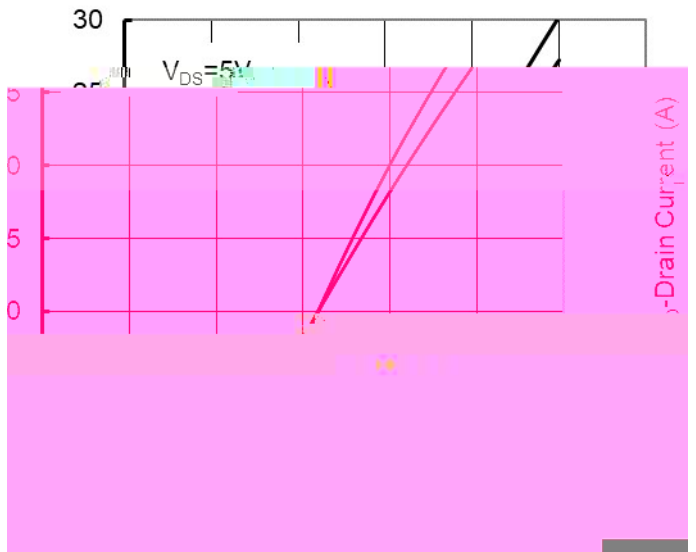
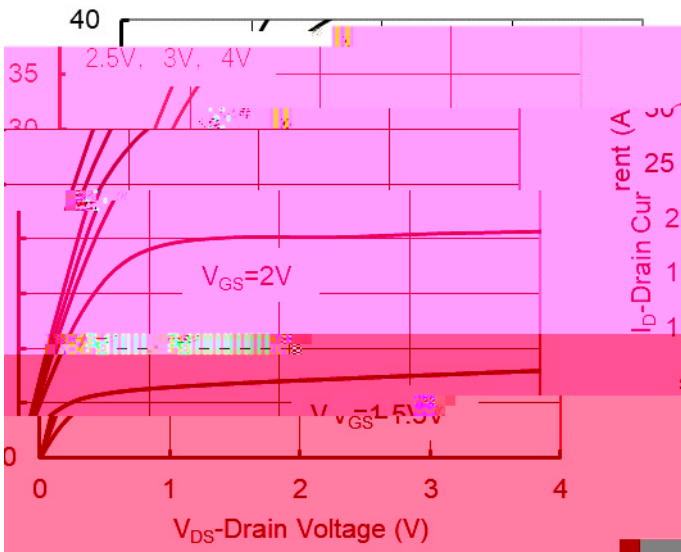

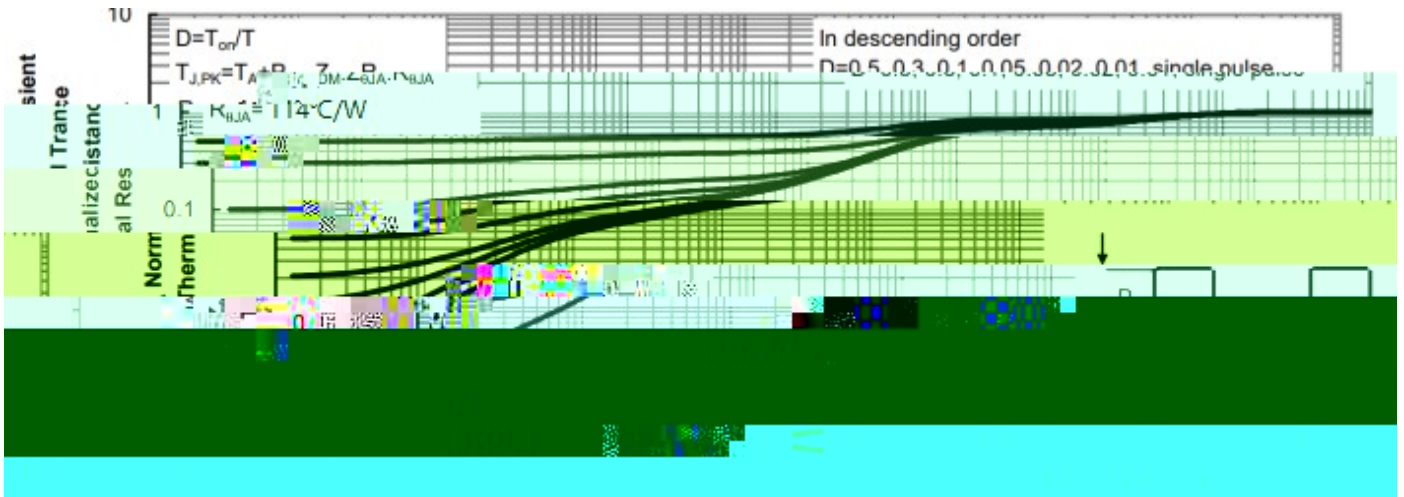
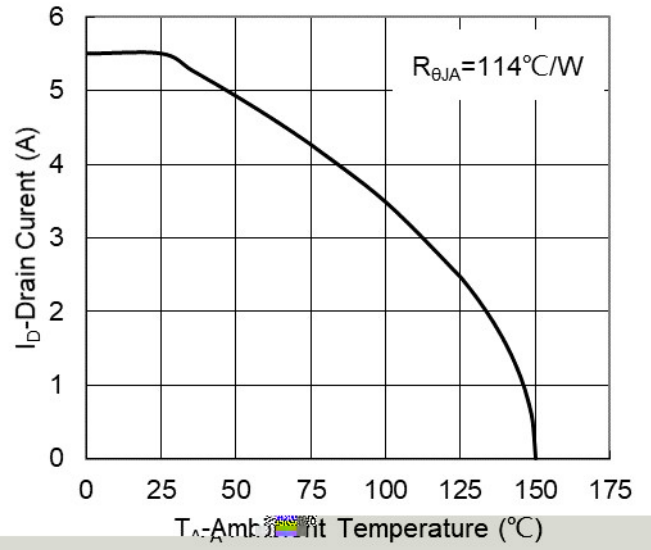
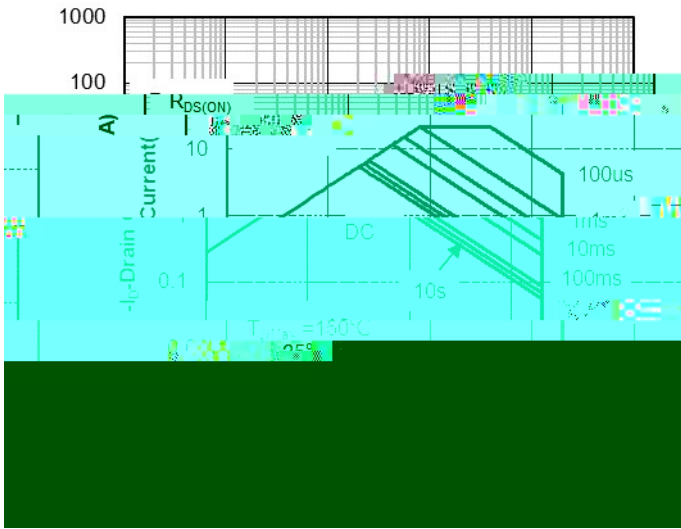

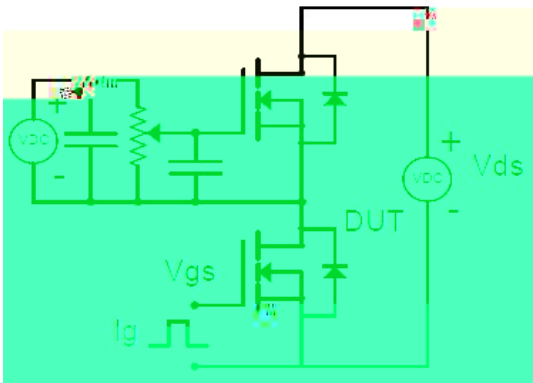
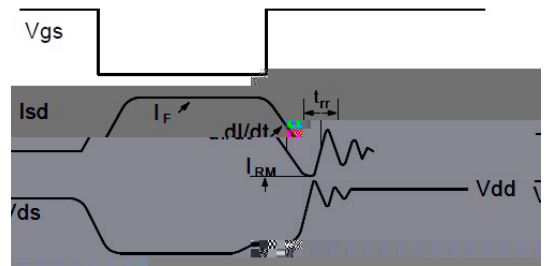
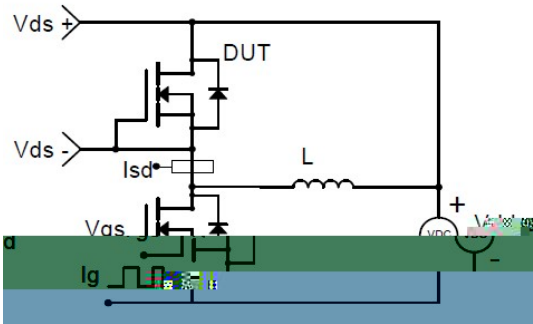
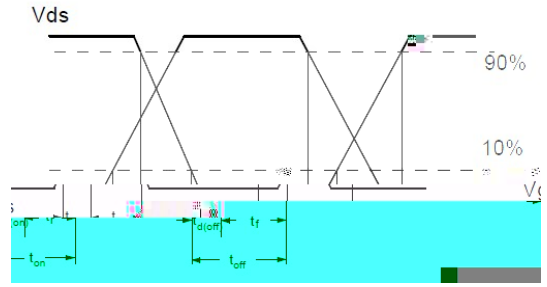
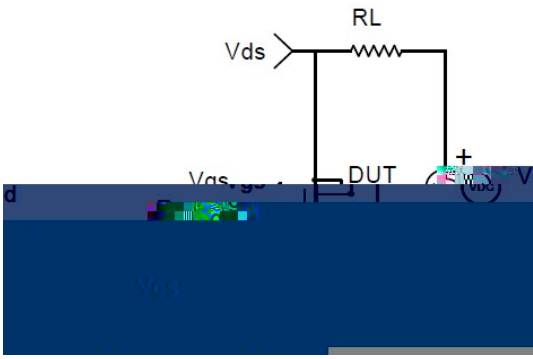

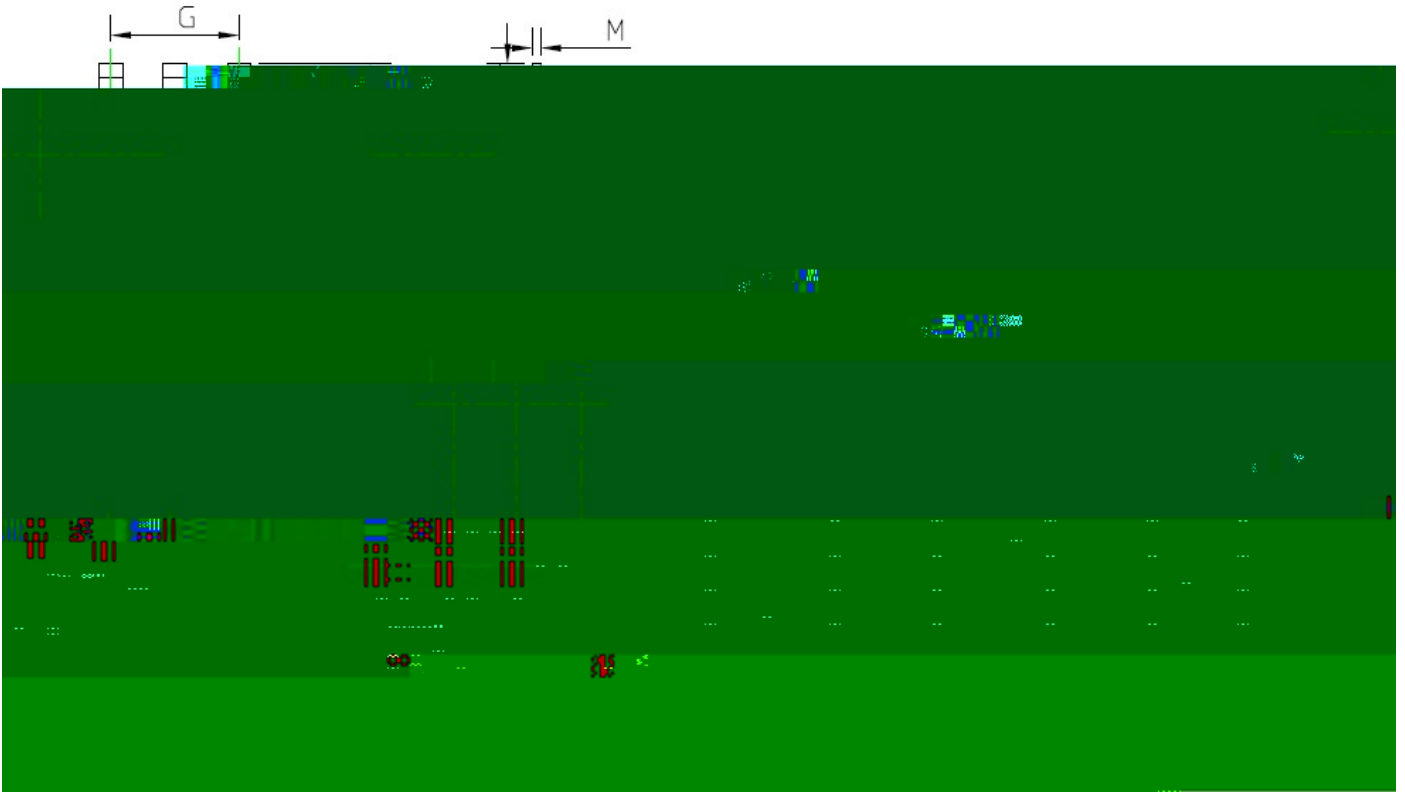



The information presented in this document is for reference only. Yangzhou Yangjie Electronic Technology Co., Ltd reserves the right to make changes without notice for the specification of the products displayed herein to improve reliability, function or design or otherwise.

The product listed herein is designed to be used with ordinary electronic equipment or devices, and not designed to be used with equipment or devices which require high level of reliability and the malfunction of which would directly endanger human life (such as medical instruments, transportation equipment, aerospace machinery, nuclear reactor controllers, fuel controllers and other safety devices), Yangjie or anyone on its behalf, assumes no responsibility or liability for any damages resulting from such improper use of sale.

This publication supersedes & replaces all information previously supplied. For additional information, please visit our website <http://www.21yangjie.com>, or consult your nearest Yangjie's sales office for further assistance.