



YJS9435B

P-Channel Enhancement Mode Field Effect Transistor

Product Summary

V_{DS}	-30 V
I_D	-5.5 A
$R_{DS(ON)}$ (at $V_{GS}=-10V$)	<41 m
$R_{DS(ON)}$ (at $V_{GS}=-4.5V$)	<59 m

General Description

Trench Power LV MOSFET technology
 High density cell design for Low $R_{DS(ON)}$
 High Speed switching

Epoxy Meets UL 94 V-0 Flammability Rating
 Halogen Free

Applications

Battery protection
 Load switch
 Power management

Absolute Maximum Ratings ($T_A=25^{\circ}C$ unless otherwise noted)

Parameter		Symbol	Limit	Unit
Drain-source Voltage		V_{DS}	-30	V
Gate-source Voltage		V_{GS}	± 20	V
Drain Current	$T_A=25^{\circ}C$	I_D	-5.5	A
	$T_A=100^{\circ}C$		-3.5	
Pulsed Drain Current ^A		I_{DM}	-30	A
Total Power Dissipation ^B	$T_A=25^{\circ}C$	P_D	2.5	W
	$T_A=100^{\circ}C$		1	
Junction and Storage Temperature Range		T_J, T_{STG}	-55~+150	$^{\circ}C$

Thermal resistance

Parameter		Symbol	Typ	Max	Units
Thermal Resistance Junction-to-Ambient ^C	Steady-State	R	40	50	$^{\circ}C/W$

Ordering Information (Example)

PREFERRED P/N	PACKING CODE	Marking	MINIMUM PACKAGE(pcs)	INNER BOX QUANTITY(pcs)	OUTER CARTON QUANTITY(pcs)	DELIVERY MODE
YJS9435B	F2	Q9435B	4000	8000	64000	



YJS9435B

Electrical Characteristics (T_J=25°C unless otherwise noted)

Parameter	Symbol	Conditions	Min	Typ	Max	Units
Static Parameter						
Drain-Source Breakdown Voltage	BV _{DSS}	V _{GS} = 0V, I _D =-	-30	-	-	V
Zero Gate Voltage Drain Current	I _{DSS}	V _{DS} =-30V, V _{GS} =0V	-	-	-1	
		V _{DS} =-30V, V _{GS} =0V, T _J =150°C	-	-	-100	
Gate-Body Leakage Current	I _{GSS}	V _{GS} = ±20V, V _{DS} =0V	-	-	±100	nA
Gate Threshold Voltage	V _{GS(th)}	V _{DS} = V _{GS} , I _D =-	-1.0	-1.5	-2.4	V
Static Drain-Source On-Resistance	R _{DS(on)}	V _{GS} =-10V, I _D =-5.5A	-	30	41	
		V _{GS} =-4.5V, I _D =-3.5A	-	46	59	
Diode Forward Voltage	V _{SD}	I _S =-5.5A, V _{GS} =0V	-	-0.9	-1.3	V
Gate resistance	R _G	f=1MHz	-	20	-	
Maximum Body-Diode Continuous Current	I _S		-	-	-5.5	A
Dynamic Parameters						
Input Capacitance	C _{iss}	V _{DS} =-15V, V _{GS} =0V, f=1MHz	-	490	-	pF
Output Capacitance	C _{oss}		-	75	-	
Reverse Transfer Capacitance	C _{rss}		-	60	-	
Switching Parameters						
Total Gate Charge	Q _g	V _{GS} =-10V, V _{DS} =-15V, I _D =-5.5A	-	9	-	nC
Gate-Source Charge	Q _{gs}		-	1.7	-	
Gate-Drain Charge	Q _{gd}		-	2.3	-	
Reverse Recovery Charge	Q _{rr}	I _F =-5.5A, di/dt=100A/us	-	12	-	nC
Reverse Recovery Time	t _{rr}		-	32	-	ns
Turn-on Delay Time	t _{D(on)}	V _{GS} =-10V, V _{DD} =-15V, I _D =-5.5A R _{GEN} =2.5	-	9	-	ns
Turn-on Rise Time	t _r		-	3	-	
Turn-off Delay Time	t _{D(off)}		-	29	-	
Turn-off fall Time	t _f		-	15	-	

A. Repetitive rating; pulse width limited by max. junction temperature.

B. P_d is based on max. junction temperature, using junction-case and junction-ambient thermal resistance.

C. The value of R is measured with the device mounted on 1 in² FR-4 board with 2oz. Copper, in the still air environment with T_A =25°C.

The maximum allowed junction temperature of 150°C. The value in any given application depends on the user's specific board design.

■ Typical Electrical and Thermal Characteristics Diagrams

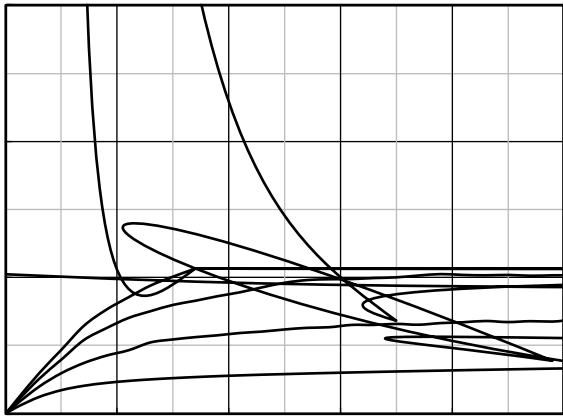

Figure 1. Output Characteristics

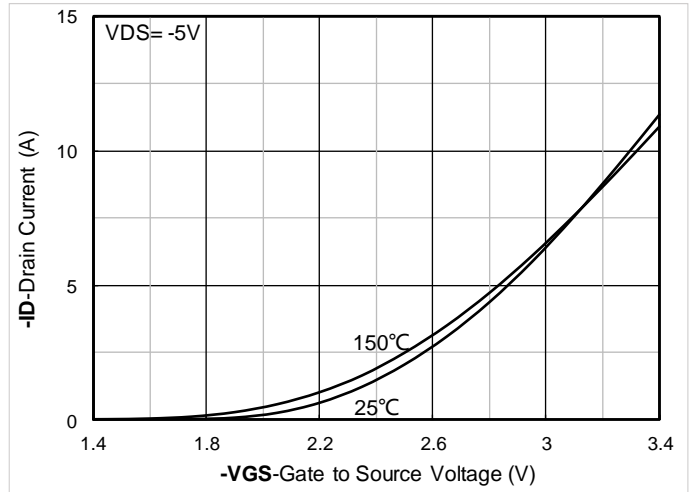

Figure 2. Transfer Characteristics

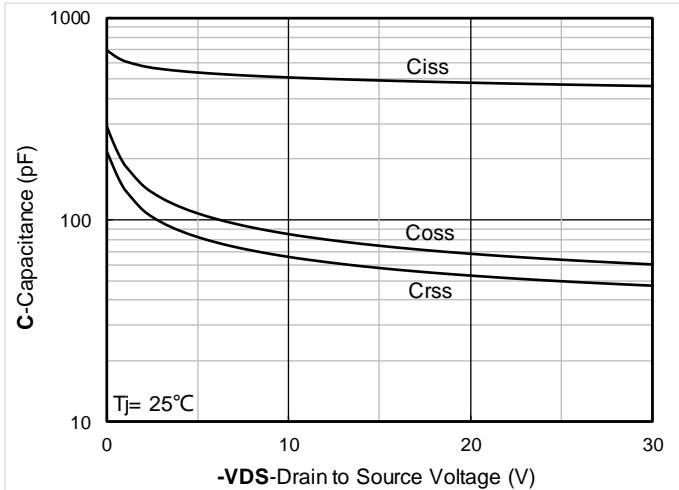

Figure 3. Capacitance Characteristics

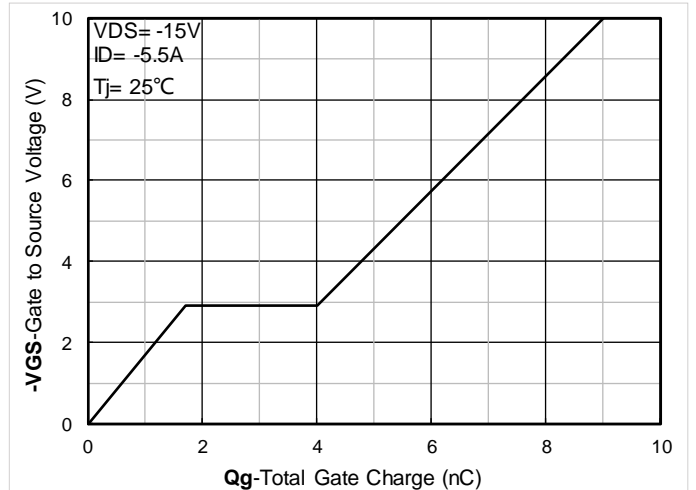

Figure 4. Gate Charge

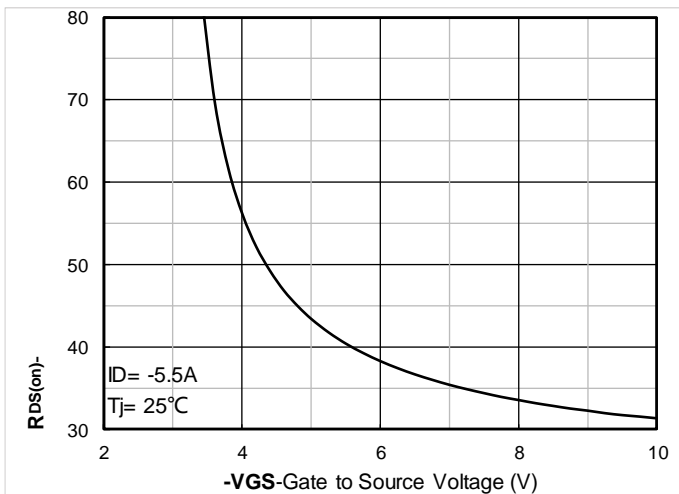

Figure 5. On-Resistance vs Gate to Source Voltage

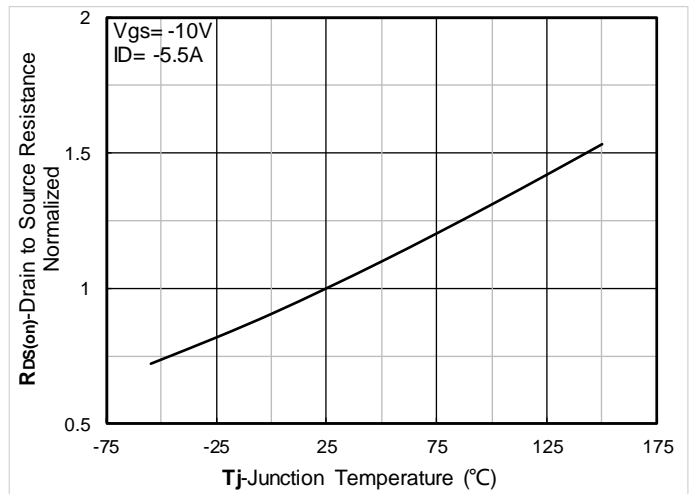

Figure 6. Normalized On-Resistance

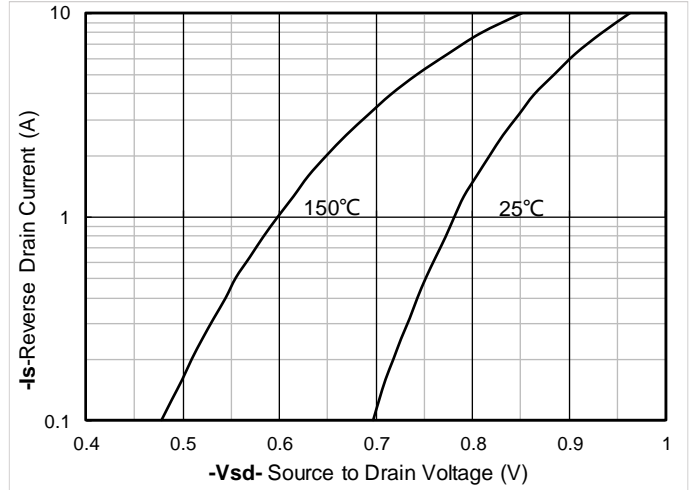

Figure 8. Forward characteristics of reverse diode

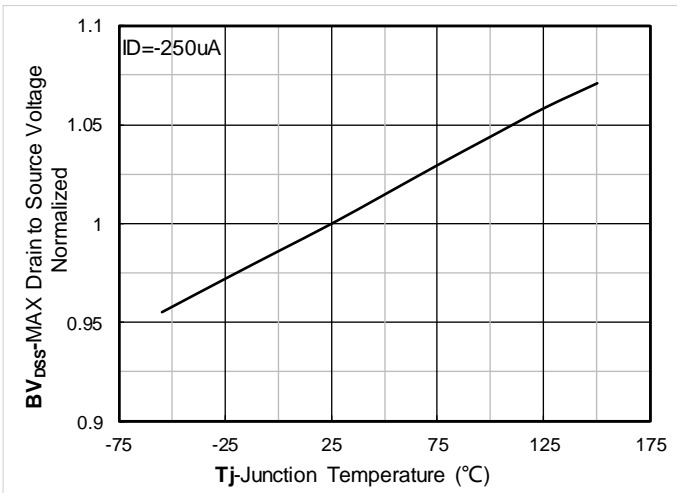

Figure 9. Normalized breakdown voltage

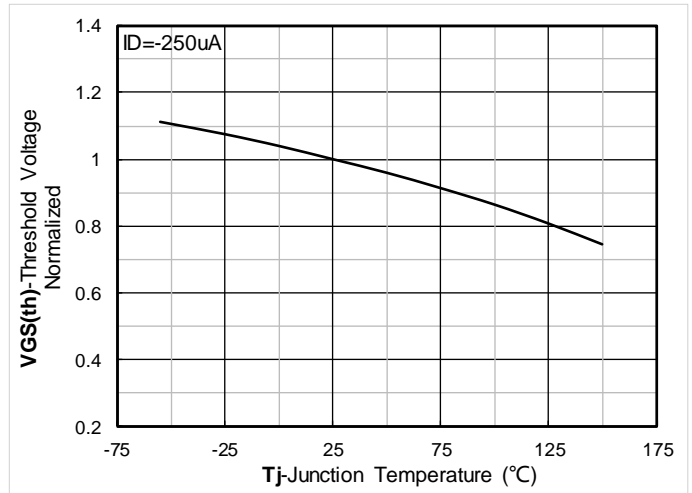

Figure 10. Normalized Threshold voltage

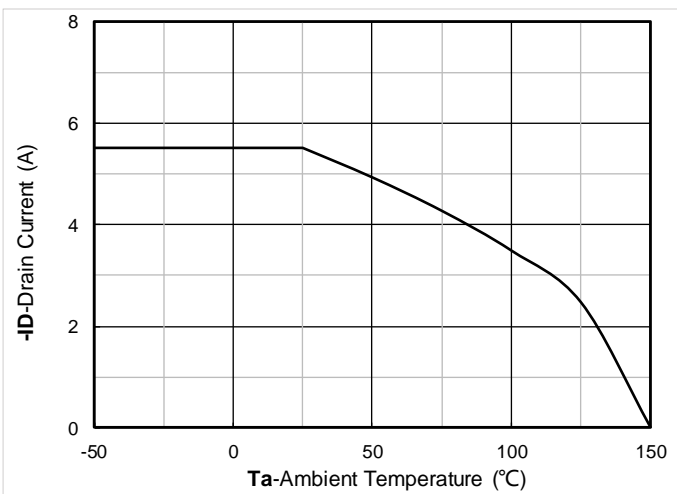

Figure 11. Current dissipation

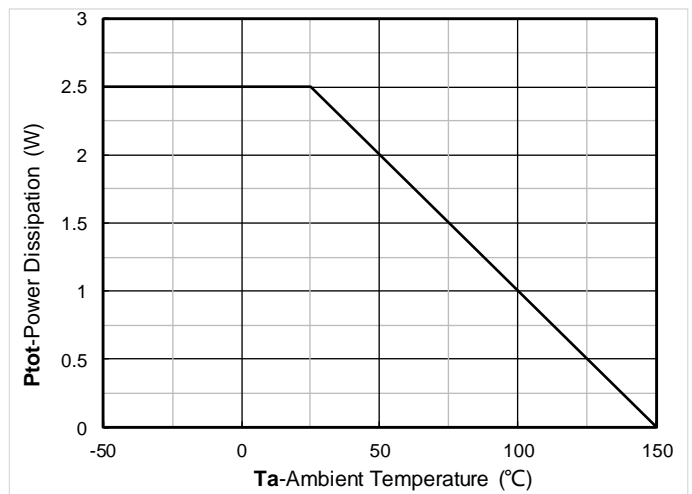

Figure 12. Power dissipation

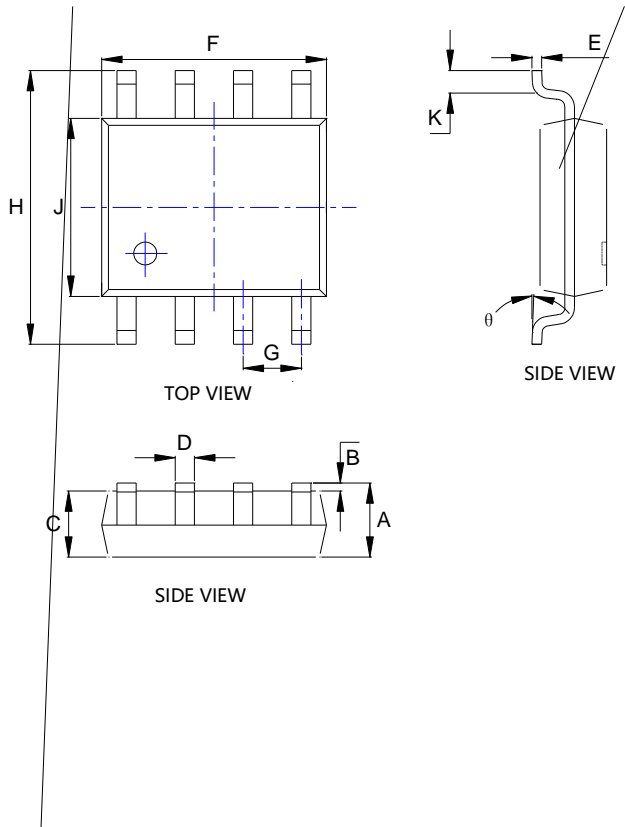

Figure 13. Maximum Transient Thermal Impedance

Figure 14. Safe Operation Area



SOP-8 Package information



SYMBOL	DIMENSIONS		
	INCHES		Millimeter
	MIN.	MAX.	MIN.
A	0.053	0.069	
B	0.004	0.010	
C		0.061	
D		0.020	
E			
F			
G	0.050BSC		1.270BSC
H			
J			
K			
	0°		



YJS9435B

Disclaimer

The information presented in this document is for reference only. Yangzhou Yangjie Electronic Technology Co., Ltd. reserves the right to make changes without notice for the specification of the products displayed herein to improve reliability, function or design or otherwise.

The product listed herein is designed to be used with ordinary electronic equipment or devices, and not designed to be used with equipment or devices which require high level of reliability and the malfunction of which would directly endanger human life (such as medical instruments, transportation equipment, aerospace machinery, nuclear-reactor controllers, fuel controllers and other safety devices), Yangjie or anyone on its behalf, assumes no responsibility or liability for any damages resulting from such improper use of sale.

This publication supersedes & replaces all information previously supplied. For additional information, please visit our website <http://www.21yangjie.com>