

Small-Signal Fast Switching Diodes

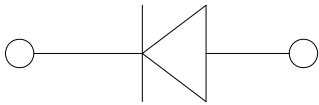
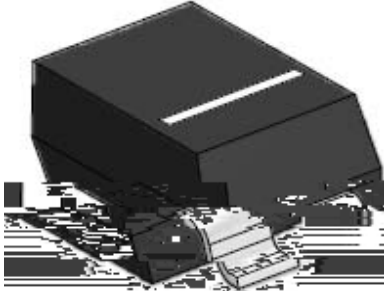

Features

- Moisture sensitivity level 1
- Reverse voltage 100V
- Average forward current 200mA

Application

- High frequency rectifier
- Signal switching

Mechanical data

- **Package** SOD-123
- **Terminals** Tin plated leads, solderable per J-STD-002 and JESD22-B102

Maximum Ratings ($T_a=25$ Unless otherwise specified)

Parameter	Symbol	Unit	Value
Device marking code			T4
Repetitive peak reverse voltage	V_{RRM}	V	100
Forward current	I_F	mA	200
Non-repetitive surge peak forward current @ t=8.3ms half-sine wave	I_{FSM}	A	1
Non-repetitive surge peak forward current @ t=1ms square wave			1.5
Power dissipation	P_D	mW	350
Junction temperature	T_J		-55 to +150
Storage temperature	T_{STG}		-55 to +150



Parameter	Symbol	Unit	Conditions
-----------	--------	------	------------

Characteristics

Fig 1 P_D-T_a Curve

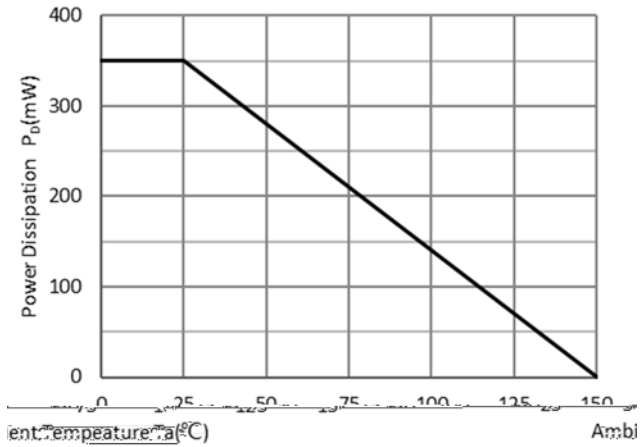

Fig 2 Capacitance Capability

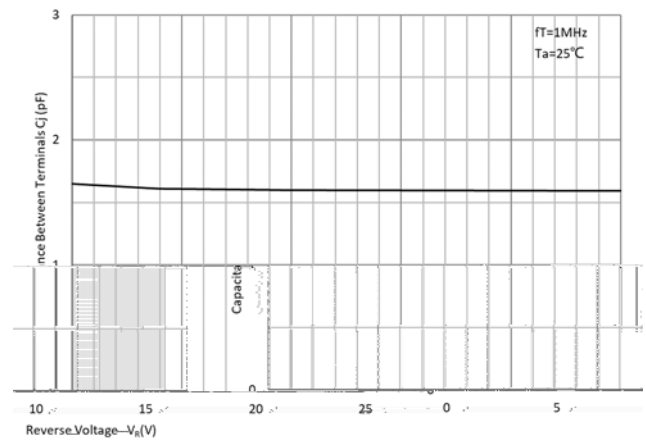

Fig 3 Typical Forward Characteristics

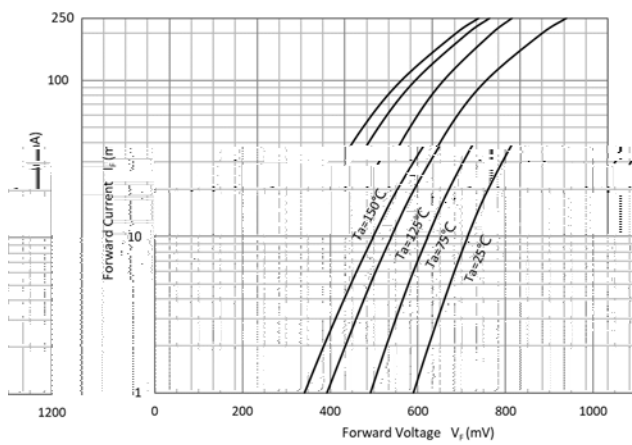
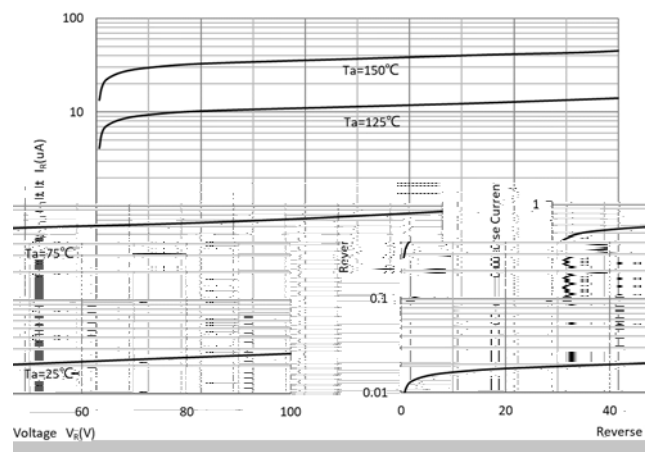

Fig 4 Typical Reverse Characteristics





Ordering Information

Preferred P/N	Packing code	Unit weight(g)	Minimum package(pcs)	Inner box quantity(pcs)	Outer carton quantity(pcs)	Delivery mode
BAS16W	F2	Approximate 0.011	3000	30000	120000	7" reel
BAS16W	F3	Approximate 0.011	10000	/	210000	13" reel

Outline Dimensions

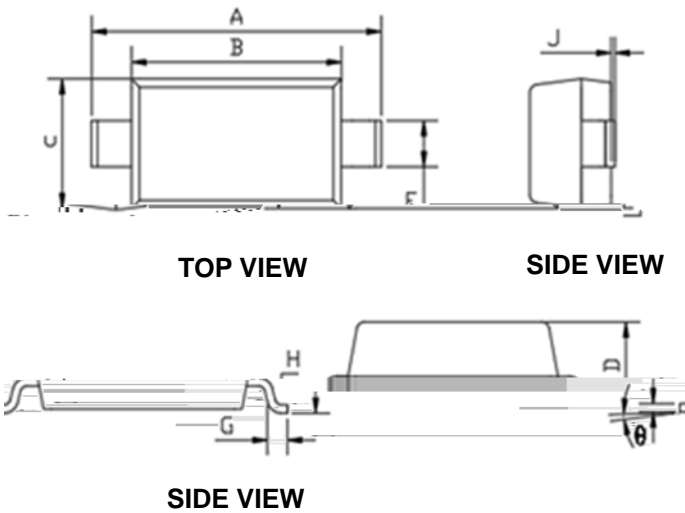

DIMENSIONS				
DIM	INCHES		MM	
	MIN	MAX	MIN	MAX
A	0.140	0.152	3.550	3.850
B	0.100	0.112	2.550	2.850
C	0.055	0.071	1.400	1.800
D	0.037	0.053	0.950	1.350
E	0.020	0.025	0.510	0.710
0.450	G	0.006	0.018	0.150
0.250	H	0.003	0.010	0.080
0.150	J	0.000	0.006	0.000
8°	θ	0	8°	0

Suggested Pad Layout

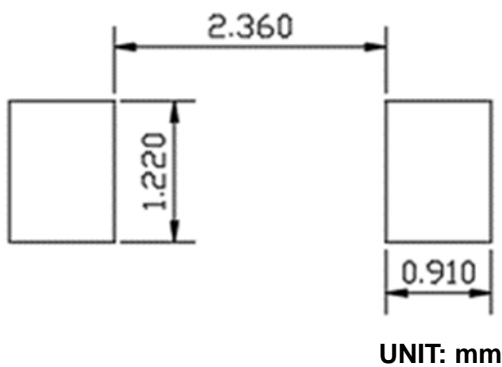



Disclaimer

The information presented in this document is for reference only. Yangzhou Yangjie Electronic Technology Co., Ltd. reserves the right to make changes without notice for the specification of the products displayed herein to improve reliability, function, or design or otherwise.

The product listed herein is designed to be used with ordinary electronic equipment or devices, and not designed to be used with equipment or devices which require high level of reliability and the malfunction of which would directly endanger human life (such as medical instruments, transportation equipment, aerospace machinery, nuclear-reactor controllers, fuel controllers and other safety devices), Yangjie or anyone on its behalf, assumes no responsibility or liability for any damages resulting from such improper use of sale.

This publication supersedes & replaces all information previously supplied. For additional information, please visit our website [http:// www.21yangjie.com](http://www.21yangjie.com) , or consult your nearest Yangjie's sales office for further assistance.